

20 Years Of Experience Engine Parts Factory Wholesale Manufacturer



SUITABLE FOR GLOBAL FAMOUS BRAND



YEM[®]

Your Engine Master

YEM[®]

What can we offer?

More than engine spare parts!



C 公司简介 COMPANY PROFILE

广州复格工程机配件有限公司位于中国广东省广州市，是一家集生产、销售为一体的工程机械配件公司。自2001年成立以来一直从事工程机械发动机配件，经过多年的努力，在同行领域颇有影响，深受客户好评。

本公司专业批发久保田，洋马、康明斯、五十铃、小松、卡特、大宇、日立、神钢、三菱、日野、沃尔沃、尼桑、利勃海尔等挖掘机替代配件。

各机型正副厂发动机件:活塞环，缸套，活塞，活塞销，大修包，汽缸床，进排气门，导管，座圈，大小瓦，止推片，连杆，曲轴，凸轮轴，水泵，机油泵，油嘴，柱塞，出油阀，机油散热器边盖，机芯，增压器经销电器件，四轮一带底盘件(包括支重轮，托轮，引导轮，驱动齿，链轨总成)

公司一贯秉承“诚信为本，服务至上，优质取胜”的理念，诚挚地欢迎国内外的新老客户前来洽谈咨询!期待与您有愉快的合作，实现双赢!

Guangzhou Fuge Construction Machinery Parts Co., Ltd. is located in Guangzhou City, Guangdong, Province, China. It is a construction machinery parts and accessories company integrating production and sales. Since its establishment in 2001, it has been engaged in engineering machinery engine parts. After years of hard work, it has a considerable influence in the field of peers and is well received by customers.

We have about 1,000,000 engine parts. We are specialized in different brands of diesel engine parts like Kubota, Yanmar, Liebherr, Isuzu, Mitsubishi, Komatsu, Perkins, Doosan, Cummins, Caterpillar, Volvo, Hino, Nissan, etc.

Engine parts of each model and auxiliary factory: piston ring, oil cylinder, piston, piston pin, large repair kit, cylinder bed, exhaust valve, guide tube, seat, size tile, thrust axle, crank column, axle pin oil fork, oil pump, oil pump, hub, cover, movement, tanker, warp beam, four pieces of equipment Wheel-rail target guidance (including rollers, drive teeth, total)

“Honesty-oriented, service first, quality win” is our principle. We sincerely welcome the new and old customers from home and abroad to negotiate and consult business. Looking forward to having pleasant cooperation with you and realizing win-win!

YEM has full private label packaging capabilities to meet all customers' need.

YEM decides to establish the international multi-languages sales teams and recruit brand agents with sincerity, the languages including:

- English
- Spanish
- Portuguese
- Arabic
- Russian
- Mongolian

YEM products are tested to OEM specifications.

YEM products are engineered and developed based on OEM samples.

YEM offer 6 months products quality warranty.

目录 Contents



2021



2022



2023



2024



2018 - In India



2020 - In Germany

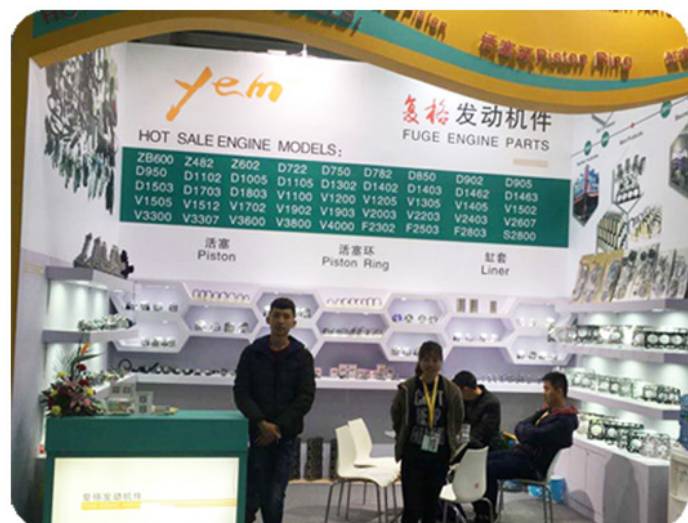

2022 - In India

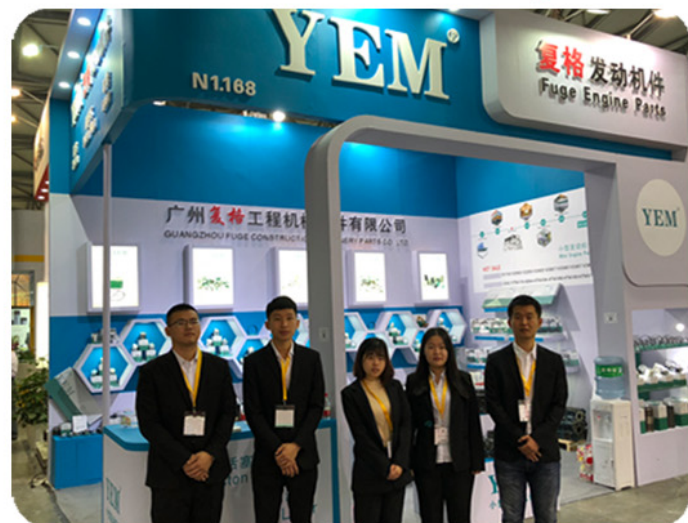

2023 - In Shanghai

发动机型号对照表.....04

活塞环系列 PISTON RING SERIES.....06

活塞系列 PISTON SERIES.....09

缸套系列 LINER SERIES.....20

缸套组件 LINER KIT SERIE.....22

大修包系列 GASKET KIT SERIES.....24

汽缸床系列 GASKET HEAD SERIES.....33

发动机总成 ENGINE ASSY SERIES.....40

缸体系列 CYLINDER BLOCK SERIES.....44

缸盖系列 CYLINDER HEAD SERIES.....47

气门系列 VALVE SERIES.....52

座圈系列 SEAT SERIES.....52

导管系列 GUIDE SERIES.....53

止推片系列 THRUST WASHER SERIES.....54

凸轮轴瓦系列 CAMSHAFT BUSHING SERIES.....55

大小瓦系列 ENGINE BEARING SERIES.....56

飞轮齿圈系列 FIY WHEEL SERIES.....63

曲轴系列 CRANKSHAFT SERIES.....64

连杆系列 CON-ROD SERIES.....69

凸轮轴系列 CAMSHAFT SERIES.....71

发动机配件 ENGINE PARTS SERIES.....73

水泵 WATER PUMP.....76

机油泵 OIL PUMP.....85

输油泵 FUEL INJECTION PUMP.....90

增压器 TURBOCHARGER.....92

喷油嘴总成 FUEL INJECTOR ASSY.....100

三偶件系列 PLUNGER/D.VALVE/NOZZIE.....102

机油散热器盖 OIL COOLER COVER.....104

机油散热器芯 OIL COOLER CORE.....106

启动马达 STARTING MOTOR.....108

发电机 ALTERNATOR.....109

风叶系列 FAN BLADE SERIES.....110

排气管 EXHAUST PIPE.....112

专题KUMATSU S6D107 SERIES.....114

增压器进(回)油管、机油管 DELIVERY LING.....118

高压油管 NOZZLE PIPING.....120

自动油门马达及配件
MOTOR ASS'Y AND PARTS.....122

水温感应器 WATER TEMP SENSOR.....125

转速传感器 REVOLUTION SENSOR.....126

电磁阀线圈 SOLENOID COIL.....127

电磁阀 SOLENOID VALVE.....128

节温器 THERMOSTAT SERIES.....130

油箱传感器 FUEL TANK SENSOR.....132

熄火开关 FLAMEOUT SOLENOID.....133

熄火电磁阀 FLAMEOUT SOLENOID VALVE.....134

油缸总成 JACK CYLINDER.....135

链轨总成 TRACK LINK ASSY.....136

履带板 TRACK SHOE.....138

引导轮 FRONT IDLER.....139

支重轮 TRACK ROLLER.....140

驱动轮 SPROCKET.....142

履带螺栓/螺母 TRACK BOLT & NUT.....143

齿块螺栓/螺母 SEGMENT BOLT & NUT.....143

刀角螺栓/螺母 PLOW BOLT & NUT.....143

挖掘机机型&发动机型号对照表

KOMATSU 小松系列					
机型	发动机型号	机型	发动机型号	机型	发动机型号
PC30	3D34	PC200-3旧	S6D105	PC300-3	S6D125-1
PC40	4D84	PC200-5	SA6D95L	PC300-5	S6D108-1
PC56-7	S4D87E-1	PC200-6	S6D95L	PC300-6	SAA6D108E-2
PC60-7	4D102	PC200-6(山推)	S6D102E-1-A	PC310	S6D108-1
PC60-8	SAA4D95LE-5	PC200-7	S6D102	PC350	S6D108-1
PC70-8	SAA4D95LE	PC200-8	SAA6D107E-1	PC300-7	6D114
PC100-1	S4D105-5	PC210-5	SA6D95L	PC360-7	6D114
PC100-3	6D95L	PC210-6	S6D95L	PC400-1	NT855
PC100-5	S4D95L-1	PC220-1	S6D105	PC400-3	S6D125-1
PC110-7	SAA4D95LE-3	PC220-2	S6D105	PC400-5	S6D125-1W
PC120-1	S4D105-5	PC220-3	S6D105-1	PC400-6	SA6D125E-2
PC120-3	6D95L	PC220-5	SA6D95L	PC400-8	SAA6D125E-5
PC120-5	S4D95L-1	PC220-6(山推)	SA6D102E-1-A	PC410	S6D125-1
PC130-7	SAA4D95LE-3	PC220-7	SA6D102E-1-A	PC450-8	SAA6D125E-5
PC150-1	6D105	PC230-6	SA6D95L	PC650-3	SA6D140
PC150-3	S6D95L	PC240LC-8	SA6D107E-1	PC710-5	SA6D104
PC200-1	6D105-1	PC300	N855	PC1000-1	S6D170B
PC200-2	S6D105	PC300-1	NT855		
PC200-3新	S6D105	PC300-2	Nt855		

HITACHI 日立系列					
机型	发动机型号	机型	发动机型号	机型	发动机型号
EX60-2	BD30	EX220	H06RCT	ZAX60	4JG1
EX90	4BD1	EX220-2	H06C-T	ZAX70	4JG1
EX100	4BD1	EX220-3	H06C-T	ZAX120	4BG1TC
EX100W	6BB1	EX270	H06CT-1	ZAX120-6	4BG1
EX100WD-2	6BB1	EX270-2	H06CT-1	ZAX200	6BG1T
EX100-2 4	4BD1-T1	EX300	EP100T	ZAX200-3G	AA-6WG1T
EX100-3	4BD1-T1	EX300-1	ERP100T	ZAX230-6	6BG1T
EX120	4BD1-T	EX300-2/3	6SD1-T	ZAX240-3	4HK1
EX120-2	4BD1-T	EX300-5	6BG1T	ZAX240-3G	AA-6WG1T
EX120-3	4BD1-T	EX400	6RB1-T	ZAX250-3	4HK1
EX120-5	4BG1	EX400-3		ZAX330-3	6HK1
EX130	4BG1	EX400-5		ZAX330-3G	AA-6HK1XQA
EX150	4BD1-T	UH-035/7	4BB1	ZAX350-3	6HK1
EX160WD	6BB1	UH04/2/5	6BB1	ZAX360-3G	AA-6HK1XQA
EX200-1旧	6BD1-T	UH05	EC100	ZAX360LC-3	AH-6HK1X
EX200-1	6BD1-T	UH055-7	6BB1	ZAX450-3	6WG1
EX200-2	6BD1-T	UH06	DA640	ZAX470-3	AH-6WG1XYSA-01
EX200-3	6BD1-T	UH06-5	6BD1		
EX200-5	6BG1	UH07-7	6BD1-T		

CATERPILLAR 卡特系列					
机型	发动机型号	机型	发动机型号	机型	发动机型号
E40B	4D32	E300B	4SA1	E320B/BL	3166
E70	4D31	E450	6D22-TC	E320C/CL	S6KT
E70B	4D32	E650	S6B-TA	E322/322L	3116
E110	4D31T	E235B/C/D	3306	E325/325L	3116
E110B	S4K-T	E245B/D	3406	E325B/BL	3116
E120B	S4K-T	E307/C	3406	E325C	3116
E120/140	6D14	E311B	4D32	E330/330	3306
E180	6D14-T	E312C/CL		E330B/BL	3306
E200/B	S6K-T	E315C/CL		E330C	C9
E240	6D15-T	E318B		E345B	
E240B	3116-T	E320/320L 旧	3066	E350/350L	3306
E300	4SA1	E320/L新	3066	E375N	3406

挖掘机机型&发动机型号对照表

KOBELCO 神钢系列					
机型	发动机型号	机型	发动机型号	机型	发动机型号
SK60	4JB1	SK210-8	J05E	SK330-8	J08E
SK100	4BD1	SK230-6E	6D34T	SK350-6	6D34
SK120-3	4BD1T	SK250-6	6D16T	SK350-8	J08E
SK120-6	6D31T	SK250-8	J05E	SK400	6D22
SK200-3	6D31T	SK260-8	J05E	SK450-6	6D24T
SK200-5	6D15	SK300	6D22T	SK460-8	P11C
SK200-6	6D34T	SK330-6	6D16	SK480-6	6D24

HYUNDAI 现代系列					
机型	发动机型号	机型	发动机型号	机型	发动机型号
R55-7	4TNV94L	R215-7C	B5.9-C	R305LC-9	JQSB6.7
R55-7S	4TNV-94L	R215-9	D6BV-C	R335LC-7	C8.3-C
R60-7	4TNV-94L	R215-9C	B5.9-C	R335LC-9	QSC
R60-9新	4TNV-94L	R220-5	6BT5.9-C	R375LC-7H	D6AC-C
R80-7	4TNV-98	R225LC-7	B5.9-C	R385LC-9	QSC
R80-9新	4TNV-98	R225LC-9T新	B5.9-C	R455LC-7	QSM11-C
R130-5	4BT3.9	R260-5	6B5.9-C	R485LC-9	QSM11
R150LC-7	B3.9-C	R265LC-7	B5.9-C	R485LC-9T新	QSM11-C
R150LC-9新	B3.9-C	R265LC-9	QSB6.7	R505LC-7	QSM11-C
R200LC	D6BR	R275LC-9T新	C8.3-C	R515LC-9T新	QSM11-C
R200-5	6BT5.9-C	R300-5	6CT8.3	R805LC-7	QSX15
R215-7	D6BT-C	R305LC-7	C8.3-C		

KATO 加藤系列					
机型	发动机型号	机型	发动机型号	机型	发动机型号
HD250	4D31	HD550SE	6D14C	HD900-2	6D14CT
HD250SE	S4F	HD550G	6DS70	HD900-5/7	
HD300GS	6DS70	HD820-2	D31-T	HD1023	6D16
HD350G	6DS30	HD700SE	6D14CT	HD1100	NH220
HD400/450	6DS70	HD700G	6D11C	HD1200G	6D22RCT
HD400G	6DS70	HD700-5	6D31-T	HD1220SE	6D22RCT
HD500/550	6DS70	HD700-5新	6D31-T	HD1250SEV	6D22T
HD400SE	6D14	HD700-7	6D31-T	HD1250-7	6D22T
HD400SEV	4D31RCT	HD800-5/7		HD1430	
HD400-5	6D31T	HD880	6D22	HD1500	NH220-V
HD450SE	6D31T	HD820	6D34	HD1800G	NH220-V
HD510	4D31-T	HD880SE-1/2	6D15RCT	HD1880SE	8DC9
Hd512	6D31-T	HD900SEV	6D15RCT		

SUMITOMO 住友系列 DOOSAN 斗山大宇系列 VOLVO 沃尔沃系列					
机型	发动机型号	机型	发动机型号	机型	发动机型号
SH45U	4D31	DH55	4JG1	EC55BLC	4TNV94
SH55	4JA1	DH60-7	4TNV94	EC140B	D4DEAE1
SH60	4JB1	DH130	DB58	EC210B	D6DEAE2
SH100	4BD1	DH170	6D16	EC240B	D7DEAE2
SH120	4BD1T	DH215-9E	DE08TIS	EC290BLC	D7DEAE2
SH145U	4D31T	DH220-3	D1146	EC360B	D10BEAE2 D12D
SH200	6BD1	DH220-5	DB58T	EC460B	D12D
SH200A3	6BG1T	DH220-9E	DE08TIS		
SH240-5	4HK1	DH258LC-V	D1146T		
SH300	D22T	DH280-3	D1146		
SH350	6D24	DH300-5	D1146T1		
SH350-5	6HK1	DH360-5	DE12T1		
SH400	6RB1	DH220-9E	DE08TIS		

活塞环系列 PISTON RING SERIES



活塞环系列 PISTON RING SERIES

品牌	机型 MODEL	零件号 PARTNO.	缸数	缸径
久保田 KUBOTA	Z482		2	68
	Z852		2	82
	Z602		2	72
	D722		3	67
	D750		3	68
	D782		3	67
	D850		3	72
	D902			
	D905		3	72
	D950		3	75
	D1005		4	76
	D1105		3	78
	D1302			
	D1305		3	78
	V1503			
	V1505	16271-2105	4	78
	D1503		3	83
	D1703		3	87
	D1803		3	87
	V1902		4	85
	V2003		4	85
	V2203	1G790-2105-3	4	87
	V2203	17331-21050	4	87
	V2203	1A091-21050	4	87
V2403		4	87	
D1803		3	87	
V3300	1C020-2105-0	4	98	
V3300	1C010-21050	4	98	
V3600		4	98	
V3800	1G514-2105-0	4	100	
V2607	17701-2105-2	4	87	
V3307	1G772-2105-0	4	94	
洋马 YANMAR	3TNE68			
	3D87		3	87
	4D82		4	82
	4D84	YM129002-22500	4	84
	4D84-1		4	84
	4D84-2		4	84
	4D84-3		4	84
	4D88	YM729350-22501	4	88
	4TNV92		4	92
	4TNV94/4TNE94	YM729906-22950	4	94
	4TNV98/4TNE98	YM129903-22050	4	98
4TNV106		4	106	
康明斯 CUMMINS	A2300	4900738	4	88
	B3.3	C6205312300	4	95
	6BT5.9	3938177	6	102
	6BT5.9	3802421	6	102
	6BT5.9	3802750	6	102
	QSB5.9	3802919	6	102
	QSB6.7	4955251	6	107
	6CT	3802429	6	114
	LT10	3803961	6	125
	M11	3803977	6	125
	NH220	AR12098	6/4	130.18
	QSX15	4089406	6	137
	N14	3804500	6	139.7
	NTA855(3803471)	3803471	6/4	139.7
	NT855(3801056)	3801056	6/4	139.7
KT19(4089500)	4089500	6	158.75	
KT19(4955795)	4955795	6	158.75	
4D94	6142-32-2030	4	94	

品牌	机型 MODEL	零件号 PARTNO.	缸数	缸径
小松 KOMATSU	4D95	6204-31-2200	4	95
	SA4D95	6202-32-2200	4	95
	S4D95	6202-32-2200	4	95
	S6D95-5	6207-31-2501	6	95
	S6D95-6	6209-31-2400	6	95
	S6D102	6732-31-2300	6	102
	S6D105	6137-31-2030	6	105
	S6D105	6137-31-2040	6	105
	S6D107	6754-31-2010	6	107
	S6D108	6221-31-2200	6	108
	S6D110	6138-31-2020	6	110
	S6D110	6138-32-2200	6	110
	4D120	6110-30-2301	4	120
	S6D125	6150-31-2033	6	125
	4D130	6114-30-2403	4	130
	6D140	6211-31-2031	6	140
	SA6D155	6128-31-2070	6	155
6D155	6128-31-2033	6/4	155	
S6D170	6162-33-2060	6	170	
五十铃 ISUZU	4LE2	8-97141208-0	4	85
	C190	8-9410495400	4	86
	C190	5-12181022-0	4/4	86
	C240	5-12121022-0	4	86
	C240	5-12121007-0	4/4	86
	C223	5-12121017-0	4	88
	4JB1	8-94247867-0	4	93
	4JG2/4JG1	8-97080215-0	4	95.4
	4JH1	8-97941122-0	4	95.4
	4BB1	5-12181005-0	4	102
	6BD1	5-12121055-0	6	102
	4BE1	8-94418918-0	6	105
	6BG1	1-12121101-0	6	105
	6BG1-TC	1-12121115-0	6	105
	6BG1-T 4RV	1-12121146-0	6/4	105
	6HE1	8-94396840-0	6	110
	6HE1-TC	8-94390529-1	6/4	110
4HF1	8-97028691-0	4	112	
4HF1	8-97109462-0	4	112	
6HK1-TC	8-94392128-1	6/4	115	
4HG1	8-97105867-0	4	115	
6HH1	8-94390799-0	6	115	
6HL1-TC	8-9760131801	6	115	
10PC1	1-12121047-0	10	119	
10PD1	1-12121062-0	10	119	
6SD1-T	1-12121119-2	6	120	
6QA1	1-12121028-0	6	125	
6RB1	1-12121040-0	6	135	
6RB1-T	1-12121073-0	6	135	
6WG1	1-12121143-0	6	147	
10PE1	1-12121129-1	4	127	
卡特 CAT	S6K-T	34317-19011	6	102
	3066	517538	6	102
	C7	107-7548	6	110
	C-9		6	112
	C9	197-9299	6	112
	3116	7e5213	6	105
	3126	1979386	6	110
	3204	2W8265	4	114.3
	3306	9S3068	6	120.65
	3306	2W1709	6	120.65
3306	2W6091	6	120.65	
3306	2114321	6	120.65	
3406	8N0822	6	137.16	



品牌	机型 MODEL	零件号 PARTNO.	缸数	缸径
	3406	1W8922	6	137.16
大宇 DAEWOO	DB58	65.02503-8058	6	102
	D1146	65.02503-8146	6	111
	D2366	65.02503-8236	6	123
	D2848	65.02503-8251	6	128
	DE08			111
	DE12T			123
沃尔沃 Volvo	D4D			98
	D6D	20460011	6	98
	D7D		6	108
	D12D			131
利勃海尔 LEIBHERR	R914	4	4	122
	R924	4	4	122
	R934	4	4	122
	R944	6	4	122
日野 HINO	W04D	13019-1973	4	104
	W06D	13019-1983	6	104
	H06C	13011-2080	6/4	108
	H06CT	13011-3281A	6/4	108
	H06CTA	13011-2450B	6/4	108
	H07D	13011-2650A	6	110
	EH700	13011-1610B	6/4	110
	H07C	13011-1620A	6	110
	H07C	13011-1620A	6/4	110
	H07C-T	13011-2672A	6/4	110
	J08E	13019-1120A	6	112
	J08C	13011-2960A	6	114
	J08CT	13011-3570A	6	114
	EB300	12011-1330	6/4	120
	EB400	13011-1630	6/4	120
	P11C	13011-3110A	8	122
	EM100	13011-1921A	6	124
	M10U	13011-2250A	6/4	127
	EF500	13011-1131	8/4	135
	K13C	13011-2841A	6/4	135
	EK100	13011-1010	6	137
	EF750	13011-2180	8	137
	EK100	13011-1010	6	137
	EF750	13011-2180	8/4	137
F17D/5mm	13011-2910A	8/4	137	
K13D/5mm	13011-2770	8/4	137	
V21C/5mm	13011-2730A	10/4	137	
F17C/5mm	13011-2810A	8/4	139	
F17E/4mm	AA92A11120	8/4	139	
V22D/5mm	13011-2920A	10/4	139	
V22C/6mm	13011-2470A	10/4	139	
F20/4MM	13011-3320A	8/4	146	
F20C	13011-2792A	8/4	146	
三菱 MITSUBISHI	4D55	MD050395	4	91.1
	4D55T	MD050390	4	91.1
	4D56	MD050390	4	91.1
	S4E	34417-11011	4	94
	4M40	ME201522	4	95
	4D30	ME012010	4	100
	4D32	ME997318	4	104
	4D34T	ME997240	4	104
	6D34T	ME997240	4	104
	4D33	ME996378	4	108
	4D35	ME996628	4	110
	6D14	ME032071	6	110

品牌	机型 MODEL	零件号 PARTNO.	缸数	缸径
三菱 MITSUBISHI	6D15	ME032403	6	113
	6D16	ME999955	6	118
	6D14T	ME997465	6	110
	6D15T	ME997466	6	113
	6D16T	ME997467	6	118
	6D22	ME052124	6	130
	6D24	ME151190	6	130
	6D22T	ME995467	6	130
	6D22T	ME995467	6	130
	6D31T/4mm	ME999783	6	100
	8DC9T/4MM	ME090758	8/4	135
	8DC9T/4mm	ME090758	8/4	135
	8DC9T/6mm	ME062018	8/4	135
	8DC10/4mm	ME090582	8/4	138
8DC10/6mm	ME065717	8/4	138	
8DC11/4mm	ME090586	8/4	142	
8DC11/5mm	ME065607	8/4	142	
8M20	ME996163	8/4	146	
日产 NISSAN	TD25	12033-44G10	4	92.9
	TD27	12033-43G11	4	96
	TD27	12033-6T010	4	96
	TD27T	12033-37N10	4	96
	TD27T	12033-0W813	4	96
	TD42	12033-06J10	6	96
	TD42T	12033-06J15	6	96
	TD42T	12033-DY712	6	96
	BD30	12033-54T10	4	96
	BD30T	12033-NA010	4	96
	ED33	12033-J6500	4	100
	FD6T	12040-Z5528	6	100
	FD6	12040-Z5028	6	100
	ND6	12040-95005	4	110
	NE6	12040-95012	6	110
	FD46	12033-0T010	4	108
	FD46T	12033-31D03	4	108
	FE6	12040-Z5504	6	108
FE6-T	12040-Z5505	6	108	
FE6-TA	12040-Z5519	6	108	
PD6	12040-90026	6	125	
PD6T	12040-96125	6	125	
PE6	12040-90225	6	133	
PE6T	12040-96225	6	133	
PF6	12040-96564	6	133	
RD8	12040-97025	8	135	
RE8	12040-97074	8	135	
RF8	12040-97072	8	138	
RG8	12040-97107	8	142	
RH8	12040-97105	8	150	
丰田 TOYOTA	1C/3mm	13011-64130	4	83
	2C/3mm	13011-64190	4	86
	2.3CT/3mm	13011-64212	4	86
	2KD	13011-30030	4	92
	2L-T	13011-54050	4	92
	1HZ	13011-17010	6	94
	B(NEW)	13011-56012	4	95
	11B	13011-56030	4	95
	11BB	13011-56040	4	95
	1KD	13011-30020	4	96
	3L	13011-54120	4	96
	2ZZ	13011-78700	4	98
	5L	13011-54130	4	99.5
13B	13011-58030	4	102	
14B	13011-58050	4	102	
15B-F	13011-58090	4	108	

活塞系列 PISTON SERIES





活塞系列 PISTON SERIES

活塞系列 PISTON SERIES



品牌	机型 MODEL	零件号 PARTNO.
久保田 KUBOTA	Z482	
	V2003	
	V2203	蜗牛白边
	V2203	1A091-21113
	V2403	1G924
		1G790-2111-3
		1G790-2112-3
		1G790-2113-3
		1G796
		1G868
		1J881
		V1505
		D1503
		V1902
		V2607
	V3307	1G774-2111-0
	V3300	1G557-2111-0
	V3300	1C010-2111-0
	V3800	1J550-2111-0
洋马 YANMAR	3TNE68	
	3D72-2	119620-22090
	3D78-1	129100-22080
	3D82-3	119813-22080
	4D84-1	
	4D84-2	
	4D84-3	
	4TNV88	
	4TNE88	
	4TNV94	
	4TNE94	129900-22080
4TNV98		
4TNE98	129903-22120	
D87T		
康明斯 CUMMINS	A2300	4900737
	B3.3 E2141	4025237
	B3.3 E2170	C6205312170
	B3.3 E2190	C6205312190
	QSB3.3	4944477
	6BT	3907163
	6BT	3926631
	6BT	3907156/3957795
	QSB5.9	3948465
	QSB6.7	4955160
	QSX15	4920306
	M11	4059948/4070653/3896030
	6CT240	3929565
	6CT240-565	3923164
	6CT	3929161
	6CT300	3917707
	6CT210	3923163
	6CT电喷	4933120
	NH220	199821/184800
NT855	3048808	
NT855	3051555/3051556/3051557	
K19	3096685	
K19	3096682	
K19	3096681	
LT10	3893751	
小松 KOMATSU	4D95 130-7	6208-31-2110
	4D95	6204-31-2121
	4D95K	6202-32-2120
	4D95L	6202-32-2140
	4D95+104凹	
	4D92	6140-31-2010
	4D94	6142-32-2110
	S6D95-5	6207-31-2141
	S6D95-6	6207-31-2180
	S6D102-7790	6735-31-2110

品牌	机型 MODEL	零件号 PARTNO.
小松 KOMATSU	S6D102(US)	
	S6D102-7795	6738-31-2110
	S6D102-0187	
	S6D102-8673	
	S4D105	6130-32-2110
	S6D105	6137-32-2110
	S6D107	6754-31-2110
	S6D108无气门位	6222-31-2116
	S6D108有气门位	6222-31-2116
	S6D110 方顶	6151-31-2150
	S6D125	6151-31-2171
	S6D125 BR	6151-31-2171
	S6D125	6150-31-2112
	S6D125	6151-32-2110
	S6D125铁PC400-5	6152-32-2510
S6D125铁PC400-6台湾	6151-31-2511	
S6D155	6127-31-2140	
S6D155	6128-31-2140	
6D105 PC200-1	6136-31-2112	
6D105 PC200-2	6136-32-2120	
五十铃 ISUZU	C223	8-94250-729-0
	C240	9-94326-225-0
	C190	5-12111-225-0
	4BC2	1-12111-775-0
	3LD1	8-97176887-0
	4LE1	8-97187582-0
	4LE2	8-97232604-0
	4JG2	8-94152-621-0
	4JB1	8-94152-177-1
	4JA1/OLD	8-94369-281-0
	4JA1/NEW	8-94562-892-0
	4BD1	1-12111-242-1
	4BE1	8-94438-989-1
	4HF1	5-87813-391-0
	4HF1	8-97095-585-1
6BD1	5-12111-303-1	
6BD1	1-12111-777-0	
4HG1	8-97183-666-0	
4HG1	8-97219-032-0	
4HK1	8-97602-800-0	
6BG1-3R	1-12111-377-4	
6BG1-3R	1-12111-435-0	
6BG1-3R	1-12111-918-0	
6BG1-4R	1-12111-574-0	
6SD1-3R	1-12111-620-1	
6SD1-4R	1-12111-651-1	
6HE1-T	8-94391-605-0	
6HE1	5-12111-837-0	
6HE1	3980	
6HK1	1-12111-526-1	
6HK1	1-12111-976-0	
6BB1	5-12111-013-0	
6BB1	5-12111-013-0	
6HH1	2420	
6HH1	5-12111-950-0	
6WG1	1-12111-964-0	
4BA1	5-12111-055-1	
10PE1	1-12111-813-0	
10PE1	1-12111-678-0	
10PD1	1-12111-804-0	
10PD1	1-12111-806-0	
E120	1-12111-080-1	
6WG1	1-12111-998-0	
6WG1	1-12111-887-0	
卡特 CAT	S6K	10200-975
	S6K	10200-985
	CAT320C S6KC	3437-01100
	CAT320D C6.4	
	CAT3306	224-3015-4246
3306	8N3102	

品牌	机型 MODEL	零件号 PARTNO.
卡特 CAT	3306	8N3182
	3306	9N5250
	3306	1073565
	C7	238-2698/262-7330/262-9288
	3126	238-2726
	3116	107-7545/238-2716
	C9	197-9297-00
	C-9	265-1401-00
	3204/3208	2W4831
	3408	2W0865
	3408	1W9372
	3406	9Y4004 9Y7212
	大宇 DAEWOO	DB58T
DB58		65.02501-0416
D1146		65.02501-0031
D1146		65.02501-0172
D1146T		0785A
D2366		65.02501-0031
D2366T		65.02501-0164
DE08T		0228B
DE12		0222B
DE12T		209
沃尔沃 VOLVO	D4D	20460009
	D6D	20460010
	D7D BF4M	20450773
	D6E	VOE21291110
	D12D	VOE3183413
利勃海尔 LEIBHERR	R914	9883110
	R924	9883110
	R934	9883110
	R944	9883110
日野 HINO	W04D	13216-1460
	W06D	13211-2070
	H06CT	13216-1810
	H07CT	13211-2152/2062
	H07C	13216-2300
	H07C	13216-2290
	H07D	13216-2260
	H07D	13216-1980
	J05E	VH13013-E0390
	J08E	VH13013-E0390
	J08C	S130A/E0030
	J08C	13306-1060
	J08C	13306-1200
	J08C	13211-3211
	J08C	13216-2631
F20C	13211-2502	
DK10	13216-1080	
EP100	13216-1450	
EL100	13216-1272	
DS50	13216-1050	
P11C铸铁		
三菱 MITSUBISHI	4D30	
	4D31	ME012131
	4D31	ME012133
	4D31	ME012135
	4D32	ME017617
	4D32	ME012174
	4D33	ME012897
	4D33	ME016895
	4D34	ME011143
	4D35	ME014693
	4D55-STD	MD050021
	4D55+0.5	MD050021
	4D55-STD	MD050021
	4D55+0.5	MD050021
	4D56T-972	ME377963

品牌	机型 MODEL	零件号 PARTNO.
三菱 MITSUBISHI	4D56T-696	ME377963
	4M40T	ME203223
	4M40T	ME200688
	4M40	ME201780
	S4Q	
	S4F	36717-41100
	S4S	32A17-00100
	S4E	34417-04100
	S4L	
	S4KT	
	S6A	32517-60200
	S6B	36217-30700
	6D11	
	6D14	ME072047
	6D14	ME032742
6D15T	ME072055	
6D15T	ME032870	
6D16	ME072062	
6D16	ME072065	
6D16	ME072065	
6D16-OLD	ME072000	
6D16	ME078502	
6D16	ME300199	
6D17	ME072546	
6D20	ME052090	
6D22	ME052588	
6D22	ME052792	
6D22	ME052447	
6D22	ME052664	
6D24T	ME158096	
6D24T	ME151409	
6D31	ME012858	
6D34	ME014160/013325	
6D34	ME014160	
6D34	ME088990	
6D34	ME082584	
6D34	ME220454	
6D34T	ME220470	
8DC9-NEW	ME090166	
6DB1	30017-90100	
6DB10		
8M20	ME161112	
尼桑 NISSAN	FE6T	
	FE6	12011-25768
	FE6	
	FE6	
	FE6	12013-25605
	FE6	
	FE6T	12011-25507
	PD6-1	12011-96009
	PD6-1	12011-96005
	PD6T	12011-96000
	PE6	
	PE6	12011-96508
	PE6T	12011-96564/96565
	PE6B	12011-96600
	TD25-STD	12010-63G11
TD25+0.5	12010-63G11	
TD25-STD	12010-63G11	
TD27-STD	12010-63G11	
TD27+0.5	12010-63G11	
TD27-STD	12010-63G11	
TD27+0.5	12010-63G11	
TD27T		
RE8		
PF6		
NE6		
QD32		

发动机件系列

发动机件系列



活塞系列 PISTON SERIES

FG-0002



KUBOTA 1G770-21110

FG-0002



KUBOTA 1J751-21110

FG-0002



KUBOTA V2403 1G796-21111

FG-0002



KUBOTA V2403 1G868

FG-0002



KUBOTA V2403 KUBOTA
V2403 1G924-21111

FG-0002



KUBOTA V2403 1J881

FG-0002



KUBOTA V3300

FG-0002



KUBOTA V3800

FG-0002



KUBOTA V2203 燃烧室47mm

FG-0002



KUBOTA V2203 KUBOTA V2403 1G790

FG-0002



KUBOTA V1902

FG-0002



KUBOTA D1503

活塞系列 PISTON SERIES



FG-0002



V3300 花式

FG-0002



V2203 IDI活塞

FG-0002



KUBOTA D1105

FG-0002



KUBOTA Z482活塞

FG-0002

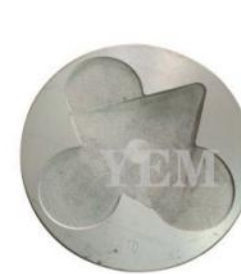

KUBOTA V3300 高度84MM

FG-0002



KUBOTA 2003

FG-0002



YANMAR 4D84-2

FG-0002



YANMAR 4D84-3

FG-0002



YANMAR 4TNE88

FG-0002



YANMAR 4TNE94

FG-0002



YANMAR 4TNE98

FG-0002



YANMAR 4TNV88

发动机件系列

发动机件系列



活塞系列 PISTON SERIES

活塞系列 PISTON SERIES



FG-0002



YANMAR 4D84-1

FG-0002



YANMAR 4TNV94

FG-0002



YANMAR 4TNV98

FG-0002



CUMMINS B3.3 4025237

FG-0002



CUMMINS B3.3 C6205312170

FG-0002



CUMMINS B3.3 C6205312190

FG-0002



CUMMINS 6BT 0187

FG-0002



CUMMINS 6BT 7790

FG-0002



CUMMINS 6BT 8673

FG-0002



CUMMINS QSB3.3 4944477

FG-0002



CUMMINS QSB5.9 3948465

FG-0002



CUMMINS QSB6.7 4955160

FG-0002



CUMMINS 6BT 3907156

FG-0002



CUMMINS 6BT 3907163

FG-0002



CUMMINS 6CT 3917707

FG-0002



KOMATSU 4D95平 6204-31-2121

FG-0002



KOMATSU 4D105 6130-32-2110

FG-0002



KOMATSU 6D95-5 6207-31-2141

FG-0002



CUMMINS 6CT 3929161

FG-0002



CUMMINS 6CT 4933120

FG-0002



CUMMINS A2300 4900737

FG-0002



KOMATSU 6D95-6 6207-31-2180

FG-0002



CUMMINS QSB6.7 4955160

FG-0002



KOMATSU PC130-7 6208-31-2110

发动机件系列

发动机件系列



活塞系列 PISTON SERIES



活塞系列 PISTON SERIES

FG-0002

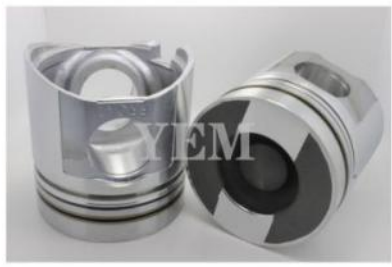

KOMATSU 6D95-6
KOMATSU S6D125 铝 阳极

FG-0002



KOMATSU S6D125 铝

FG-0002



KOMATSU S6D155 6127-31-2140

FG-0002



ISUZU 6HK1 1-12111-9760

FG-0002



ISUZU 6BG1-3 1-12111-377-4

FG-0002



ISUZU C240-3 9-94326-225-0

FG-0002



KUMATSU PC130-8活塞

FG-0002



ISUZU 4LE2 8-97232604-0

FG-0002



ISUZU 4HK1 6HK1 8-97602-800-0

FG-0002



ISUZU 6HK1 1-12111-9760

FG-0002



CAT 320C 3437-01100

FG-0002



CAT 320D C6.4

FG-0002



ISUZU 4JB1 方 8-94152-177-1

FG-0002



ISUZU 4JB1 圆底 销孔34

FG-0002



ISUZU 4JB1圆 销31

FG-0002



CAT C9

FG-0002



CAT C7 238-2698 262-7330

FG-0002



CAT S6K 10200-975

FG-0002



ISUZU 4LE1 8-97187582-0

FG-0002



ISUZU 6BD1 1-12111-777-0

FG-0002



ISUZU 6BG1方 1-12111-918-0

FG-0002



DAEWOO D2366尖 65.02501-0031

FG-0002



DAEWOO DB58-7 65.02501-0416

FG-0002



DAEWOO D1146尖 65.02501-0031

发动机件系列

发动机件系列



活塞系列 PISTON SERIES

FG-0002



DAEWOO D1146平 0785A

FG-0002



DAEWOO DB58-5 65.02501-0561

FG-0002

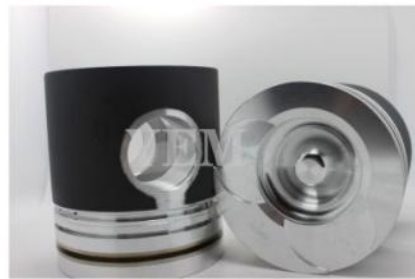

DAEWOO DE08T 022B

FG-0002



DAEWOO D2366平 65.02501-0164

FG-0002



DAEWOO DE12T 0209

FG-0002



VOLVO D12D活塞 20451076

FG-0002



VOLVO D6D 20460009

FG-0002



VOLVOD7D 20450773

FG-0002



HINO J08E VH130B-E0390

FG-0002



HINO W04D 13216-1460

FG-0002

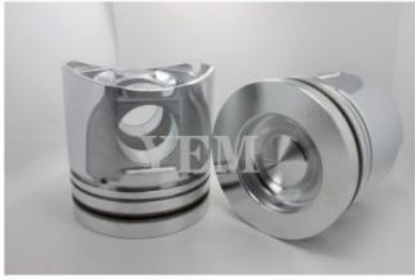

LIEBHERR 9883110

FG-0002



MITSUBISHI 4M40 Me201780

活塞系列 PISTON SERIES

FG-0002

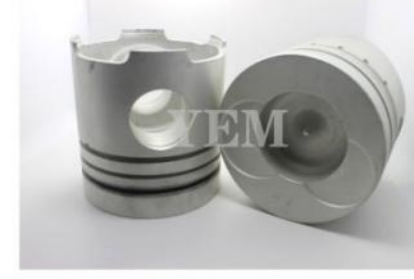

MITSUBISHI 6D24 Me151409

FG-0002



MITSUBISHI 6D31 Me012858

FG-0002



MITSUBISHI 6D34 Me082584

FG-0002



MITSUBISHI 6D34 Me088990

FG-0002



MITSUBISHI 6D34 Me220454

FG-0002



MITSUBISHI S4F

FG-0002



MITSUBISHI S4L

FG-0002



MITSUBISHI SE4 34417-04100

FG-0002



MITSUBISHI S4Q2

FG-0002



MITSUBISHI 6D16 Me072000

FG-0002



MITSUBISHI 6D16 Me072062

FG-0002



MITSUBISHI 6D16 Me072065

FG-0002



MITSUBISHI 6D16 Me300199

FG-0002



MITSUBISHI S4S

缸套系列 LINER SERIES



缸套系列 LINER SERIES

品牌	机型 MODEL	零件号 PARTNO.	尺寸 SIZE
久保田 KUBOTA	D1503		Φ86.6*Φ81.6*Φ156
	V2203		Φ86*Φ90.5*Φ150
	V2203+A		Φ86*Φ91*Φ150
	V3300		Φ97*Φ101.6*Φ187
	V3800		Φ99*Φ104*191
	3TNE82		Φ86.5*Φ90.5*Φ128
	洋马 YANMAR	4T84	
4T88			Φ87*Φ91*Φ182
V88+A			Φ87*Φ92*Φ182
4TNV94			Φ93*Φ98*Φ190
4TNV94			Φ93*Φ99*Φ190
4TNV98			Φ97*Φ101.6*Φ187
4TNV98+A			Φ97*Φ102*Φ187
康明斯 CUMMINS	A2300.F	4900214	Φ88*Φ91*Φ153
	B3.3		
	6BT		Φ101*Φ104.5*200
	6BT	3904166	Φ101*Φ105*200
	6BT		Φ101*Φ106*200
	6BT		Φ101*Φ107*200
	6CT	3919937	Φ114*Φ131*236
	6CT	3802406	Φ114*Φ131*236
	6CT	3802407	Φ114*Φ131*236
	M11/LT10	3080760	Φ125*Φ146*241
	NH220	6610-21-2212	
NT855	3055099	Φ139.7*Φ166.7*288.2	
K19	4009220		
小松 KOMATSU	4D95	6207-21-2110	Φ94.2*Φ98*180
	S4D95	6207-21-2121	Φ94.2*Φ98*180
	6D95		Φ94*Φ98*181
	6D95		Φ94*Φ99*181
	6D95		Φ94*Φ100*181
	6D102	6736-29-2140	Φ101*Φ105*200
	S6D105	6136-21-2210	Φ105*Φ127*233
	6D107		Φ106*Φ110*203
	6D107		Φ106*Φ111*203
	6D107		Φ106*Φ112*203
	S6D108.F		108*111.3*220
	S6D110	6138-21-2210	Φ110*Φ115*225
	S6D125	6150-21-2221	Φ125*Φ153*256
	S6D140		
S6D155	6128-21-2215	Φ155*Φ184*327	
S6D170	6162-23-2210		
五十铃 ISUZU	3LD1		
	4LE1		Φ84*Φ89*Φ150
	4LE2		
	C240.F	9-11261-230-0	Φ86*Φ88*Φ178
	C190	9-11261-210-0	
	C223	9-11261-015-1	
	4JA1	8-94110-114-0	
	4JB1	8-94247-861-0	
	4JG1	8-97176-701-0	
	4BC2	8-97176-701-0	
	4BE1	5-11261-016-2	
	4HF1	8-94389-276-1	Φ112*Φ115*180
	4HG1	8-97351-558-0	Φ115*Φ118*180
	6BD1		
	6BG1	1-11261-250-0	
	DA120	9-87692-095-0	Φ100*Φ119*220

品牌	机型 MODEL	零件号 PARTNO.	尺寸 SIZE
五十铃 ISUZU	6SD1T	1-11261-106-2	Φ120*Φ123*239
	6HE1	8-94396-332-0	Φ110*Φ113*210
	6HH1		
	6RB1/E120		Φ132*Φ137*266
	6HK1.F		115*118*210
	卡特 CAT	3406	2W6000
3116			
C7			104*109.3*197
C9			
S6KT		5I-7523	Φ101.2*Φ105*196
3306	2P8889	Φ120.7*Φ143*255	
大宇 DAEWOO	DB58.F	65.01201-0067	Φ102*Φ106*206
	D1146.F	65.01201-0050	Φ111*Φ114*234
	D2366.F	65.01201-0051	Φ123*Φ127*270
本田 HINO	WO4D	11467-1781	Φ104*Φ107*201
	W06D	11467-1771	Φ104*Φ107*200
	EL100		Φ116*Φ138*222
	EK100	11467-1270	Φ137*Φ164*267
	EF750	11467-1091	Φ137*Φ165*248
	EF550	11407-1690	Φ135*Φ165*248
	F17C	11467-1702	Φ139*Φ166*248
	EH700	11467-1200	
	H07CT	11467-1210	Φ110*Φ113*204
	EH100	11467-1040	Φ105*Φ110*206
J05E/J08E.F	11467-2611	Φ112*Φ115*203	
沃尔沃 volvo	D6D		Φ97*Φ101*104.8
	D6D+		Φ97*Φ102*104.8
	D6D.F		Φ98*Φ101*104.8
	D6E		Φ97*Φ101*188
	D6E+		Φ97*Φ102*188
	D6E.F		Φ98*Φ101*188
尼桑	BD30		
三菱 MITSUBISHI	4D55	MD050430	Φ90*Φ94.1*164.5
	4D56	MD103648	Φ90*Φ94.1*164.5
	4D31/6D31	ME011626	Φ99*Φ104*191
	6D31+A		Φ99*Φ105*191
	4D34/4D32/6D34	ME013366	Φ103*Φ108*197.5
	6D34+A		Φ102*Φ109*Φ197
	4D33	ME013333	Φ107*Φ112*200
	4D35	ME013678	Φ109*Φ114*200
	S4S	32A07-00300	
	4M40		Φ94*Φ98*Φ168
	S4L		Φ77*Φ81.6*Φ156
	S4Q2		Φ86.5*Φ92*Φ160
	S6K	34307-00501	Φ101.2*Φ105*196
	6D14	ME031617	Φ110*Φ130*206
	6D14T	ME071198	Φ110*Φ130*206
	6D15	ME031656	Φ112*Φ117*206
	6D16.F	ME071224	Φ118*Φ122*205
6D16新		Φ118*Φ122*205	
6D16T	ME041105	Φ118*Φ122*205	
6D22	ME051500	Φ130*Φ155.5*261.5	
6D22T	ME051217	Φ130*Φ155.5*261.5	
8DC8	ME061036	Φ135*Φ163*229.7	
8DC9	ME062602	Φ135*Φ163*260.6	
8DC11	ME060439	Φ142*Φ163*259.5	

发动机件系列

缸套组件 LINER KIT



缸套组件 LINER KIT

KUBOTA	YANMAR	KOMATSU	ISUZU	CAT	mitsubishi
Z482	3TNE68	4D94	3LD1	S4K-T	S4F
Z852	3D87	4D95	4LE1	S6K-T	S4E
Z602	4D82	S6D95-5/6	4LE2	3066	4M40
D722	4D84	S6D102	C240	C6.4	4D31T
D750	4D84-1	S6D105	4JB1	C7	4D34T
D782	4D84-2	S4D105	4JG2/4JG1	C-9	6D31T
D850	4D84-3	S6D107	4JJ1	C9	6D34T
D902	4TNE88/4TNV88	S6D108	4HK1	3116	6D14
D905	4TNV92	S6D110	4BD1	3126	6D15
D950	4TNV94/4TNE94	4D120	6BD1	3204	6D16
D1005	4TNV98/4TNE98	S6D125	4BG1	3306	6D14T
D1105	4TNV106	4D130	6BG1-3/-4	3406	6D15T
D1302		6D140	6HK1直喷		6D16T
D1305	CUMMINS	SA6D155	6HK1电喷	VOLVO	6D22
V1503	A2300	S6D170	6SD1	D4D	6D24
V1505	B3.3		6WG1直喷	D6D/D6E	
D1503	6BT5.9	HINO	6WG1电喷	D7D	NISSAN
D1703	QSB5.9	W04D		D12D	BD30
D1803	QSB6.7	W06D	DAEWOO		PF6T
V1902	6CT	H06C	DB58	LIEBHERR	RD8
V2003	LT10	H06CT	D1146	R914	FE6
V2203	M11	H07C	DE08	R924	FD6
V2403	NH220	H07D	D2366	R934	NE6
V3300	QSX15	J08E	DE12T	R944	RF8
V3600	N14	J08C			Qd32
V3800	NTA855	J05E			
V2607	KT19				
V3307					

大修包系列 GASKET KIT SERIES



KUBOTA	YANMAR	KOMATSU	ISUZU	CAT	mitsubishi
Z482	3TNE68	4D94	3LD1	S4K-T	S4F
Z852	3D87	4D95	4LE1	S6K-T	S4E
Z602	4D82	S6D95-5	4LE2	3066	4M40
D722	4D84	S6D102	C240	C6.4	4D31T
D750	4D84-1	S6D105	4JB1	C7	4D34T
D782	4D84-2	S4D105	4JG2/4JG1	C-9	6D31T
D850	4D84-3	S6D107	4JJ1	C9	6D34T
D902	4D88	S6D108	4HK1	3116	6D14
D905	4TNV92	S6D110	4BD1	3126	6D15
D950	4TNV94/4TNE94	4D120	6BD1	3204	6D16
D1005	4TNV98/4TNE98	S6D125	4BG1	3306	6D14T
D1105	4TNV106	4D130	6BG1	3406	6D15T
D1302		6D140	6HK1直喷		6D16T
D1305	CUMMINS	SA6D155	6HK1电喷	VOLVO	6D22
V1503	A2300	S6D170	6SD1	D4D	6D24
V1505	B3.3		6WG1直喷	D6D	
D1503	6BT5.9	HINO	6WG1电喷	D7D	NISSAN
D1703	QSB5.9	W04D		D12D	PF6T
D1803	QSB6.7	W06D	DAEWOO		RD8
V2003	6CT	H06C	DB58	LIEBHERR	FE6
V2203	LT10	H06CT	D1146	R914	FD6
V2403	M11	H07C	DE08	R924	NE6
D1803	NH220	H07D	D2366	R934	RF8
V1902	QSX15	J05E	DE12T	R944	
V3300	N14	J08E			
V3600	NTA855	J08C			
V3800	KT19				
V2607					
V3307					

大修包系列 GASKET KIT SERIES

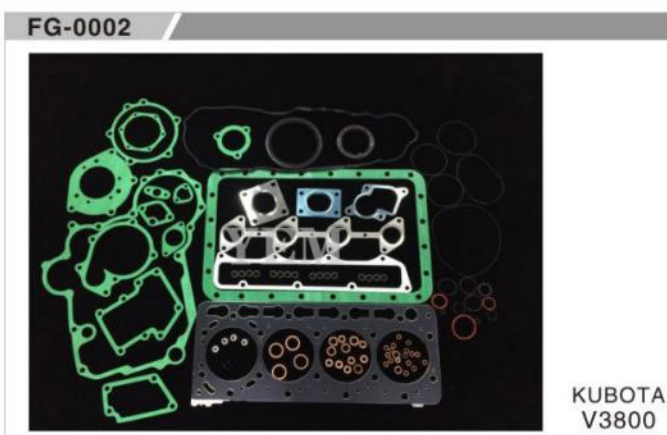
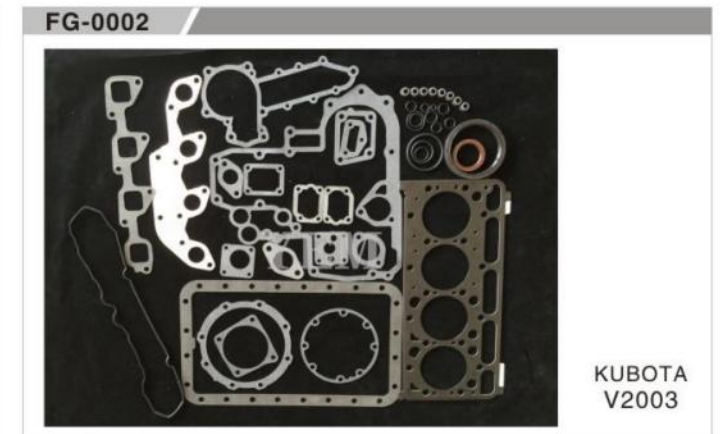
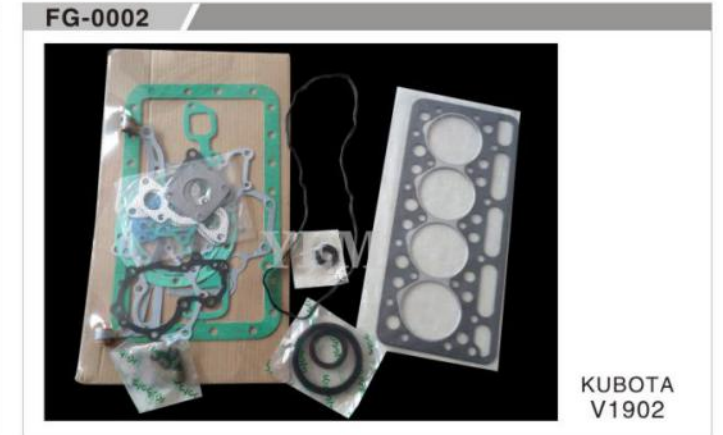

发动机件系列



大修包系列 GASKET KIT SERIES

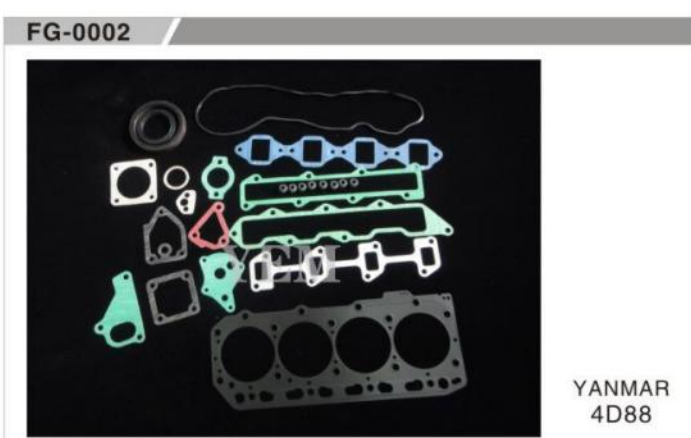
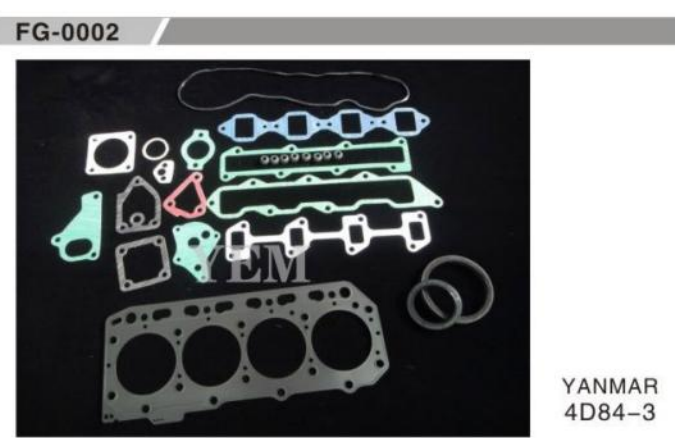
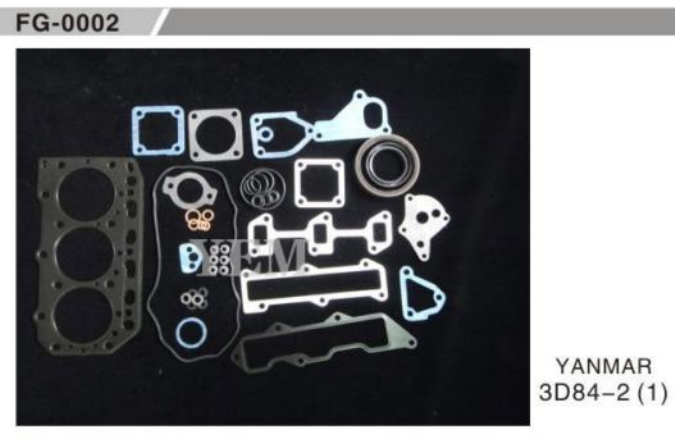

大修包系列 GASKET KIT SERIES

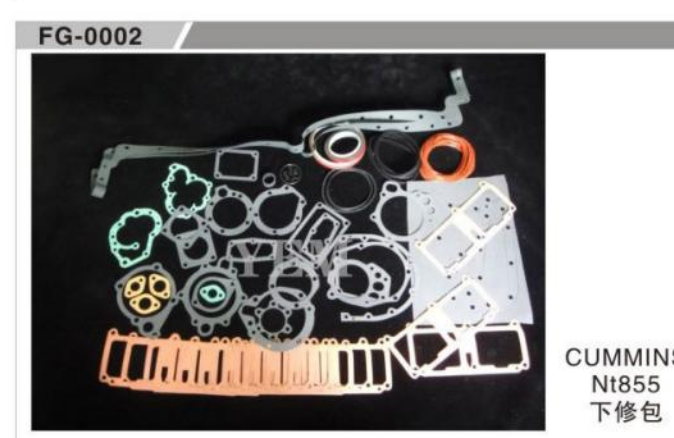
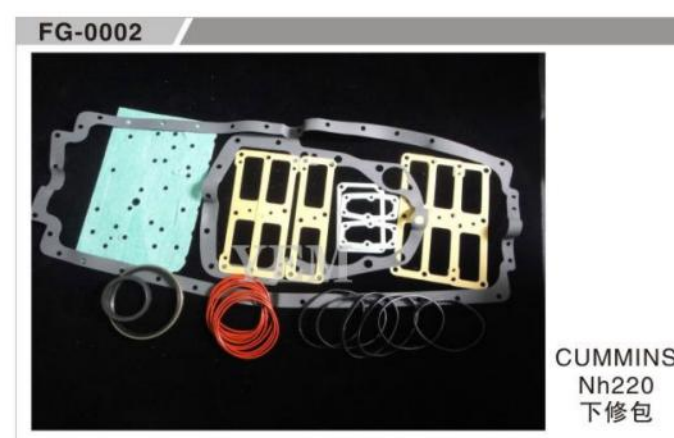
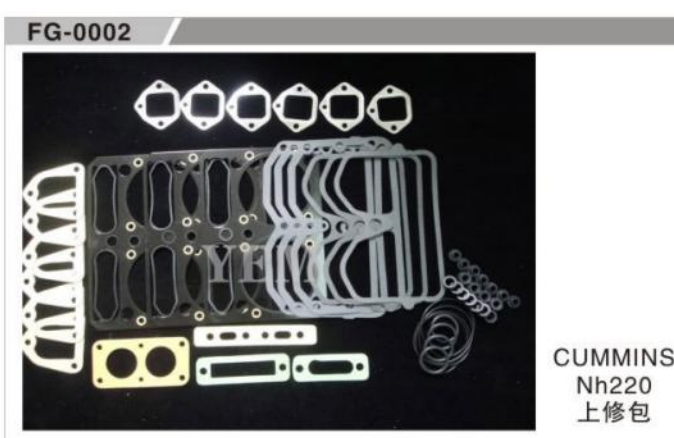

发动机件系列

发动机件系列



大修包系列 GASKET KIT SERIES

大修包系列 GASKET KIT SERIES

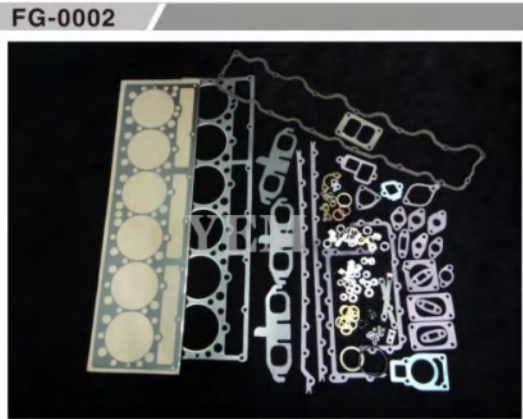

CAT
3306
上修包

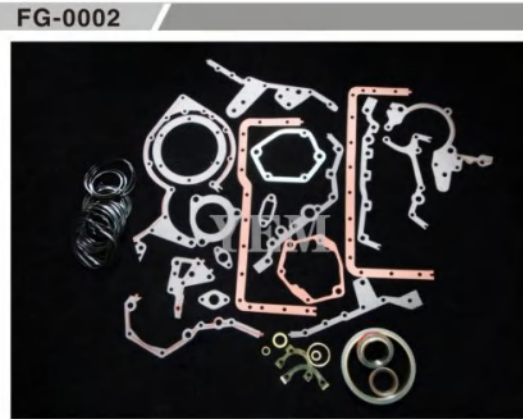

CAT
3306
下修包

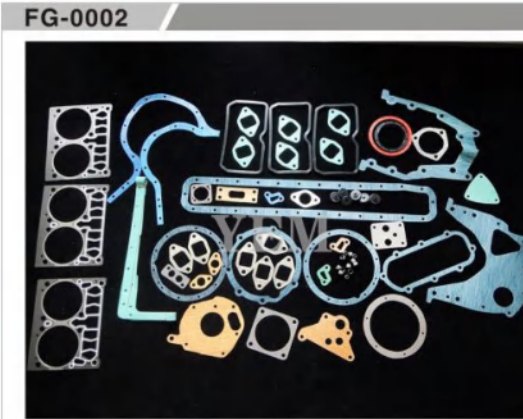

DAEWOO
D1146



DAEWOO
DB58



CAT
3116

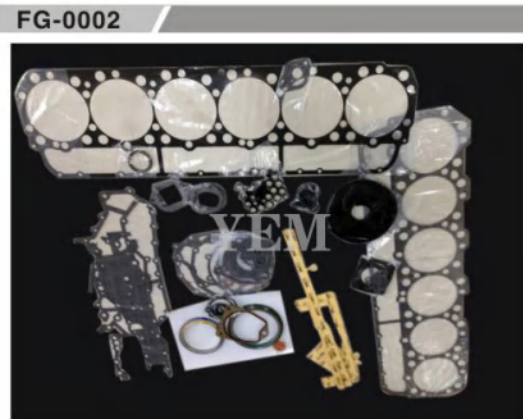

CAT
3406

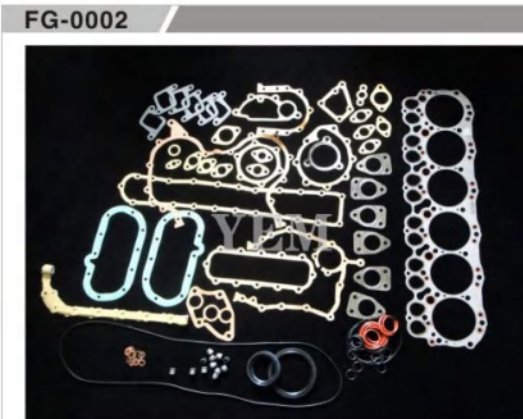

HINO
H07C



HINO
J05E



CAT
C9

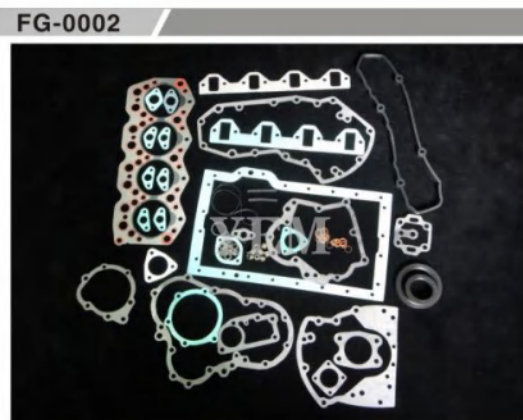

CAT
S4F



HINO
J08E

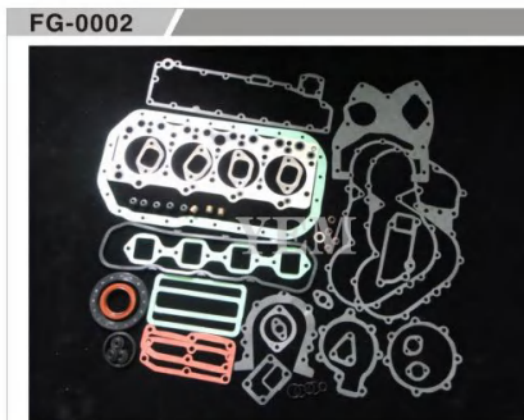

ISUZU
4BD1



CAT
S4K



CAT
S6K

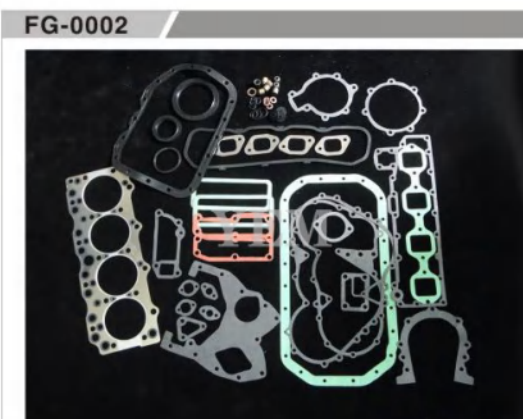

ISUZU
4BG1



ISUZU
4HK1

发动机件系列

发动机件系列



大修包系列 GASKET KIT SERIES

大修包系列 GASKET KIT SERIES

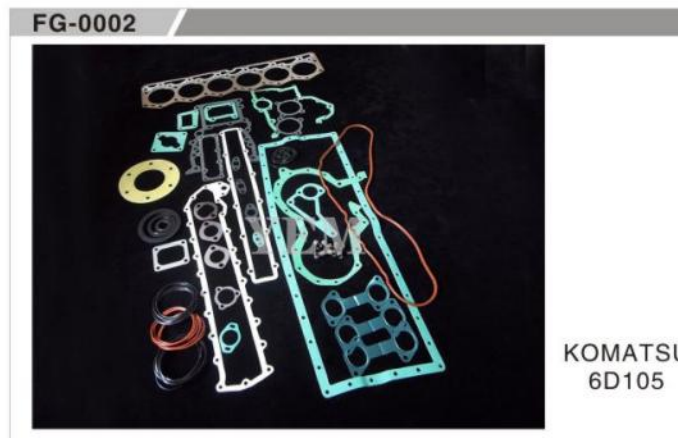
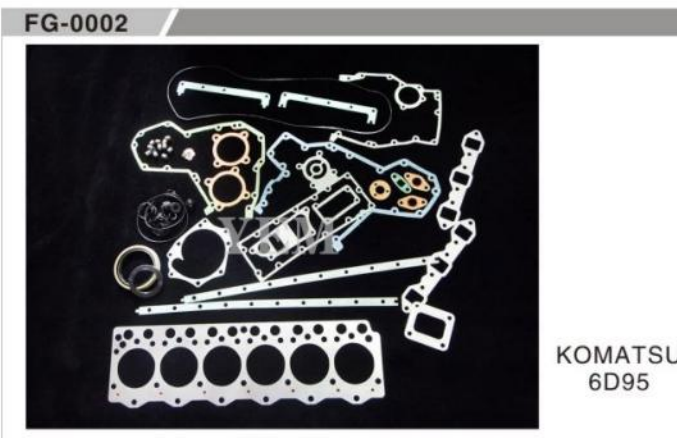
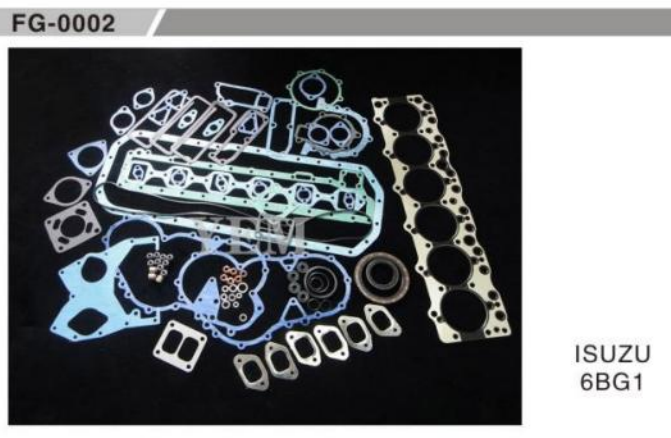
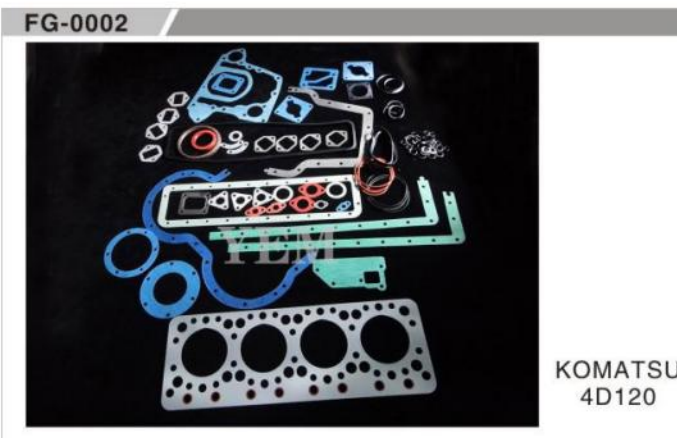
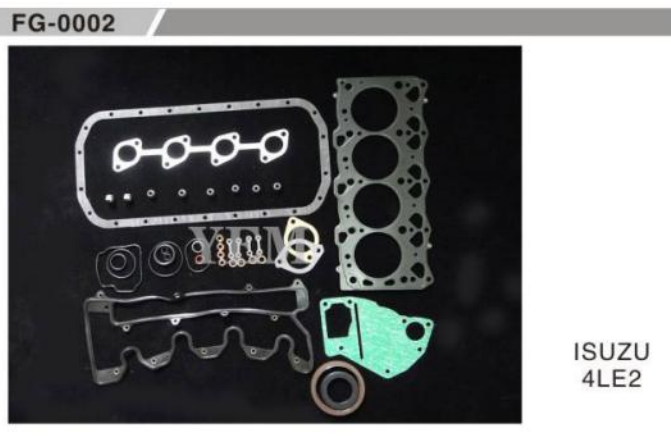
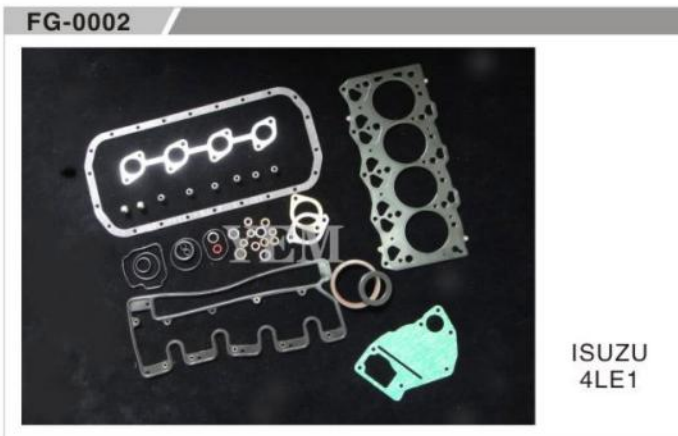
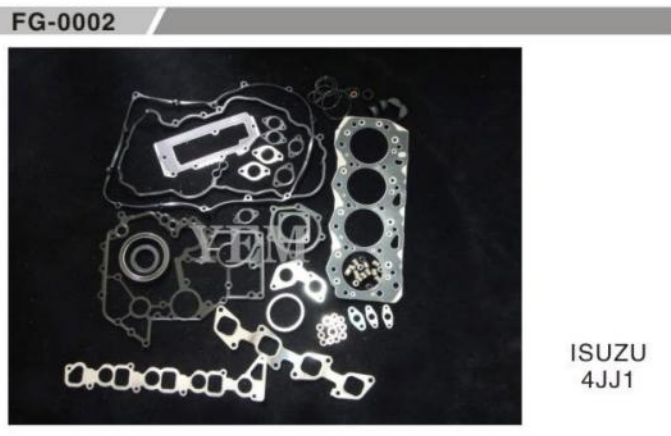
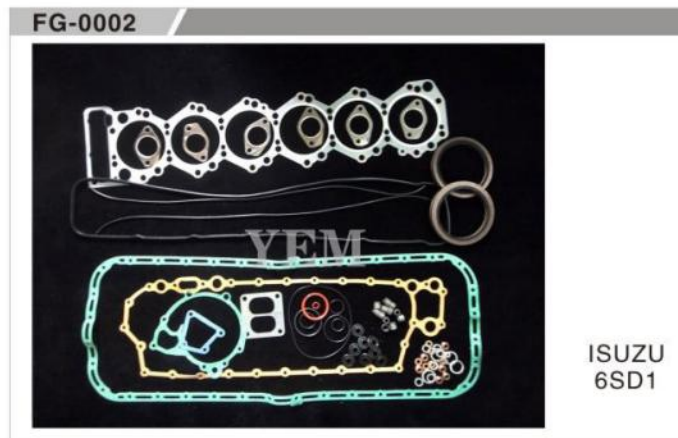
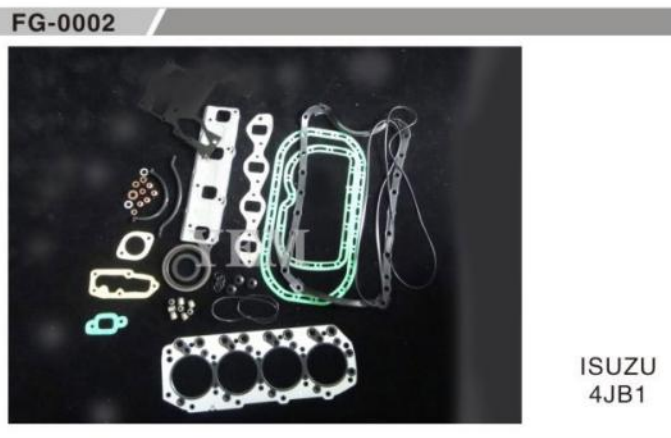

发动机件系列

发动机件系列



KOMATSU 6D107



KOMATSU 6D108

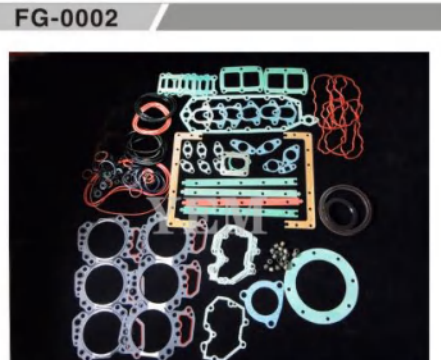

KOMATSU 6D125



MITSUBISHI 4M40



MITSUBISHI 6D14T



MITSUBISHI 6D15T



MITSUBISHI 6D16T



MITSUBISHI 6D22



MITSUBISHI S6E FULL GASKET



MITSUBISHI S4L



MITSUBISHI S4S



MITSUBISHI S6S



KUBOTA D1703



KUBOTA V1005



KUBOTA V1105



KUBOTA V1702



KUBOTA V1902

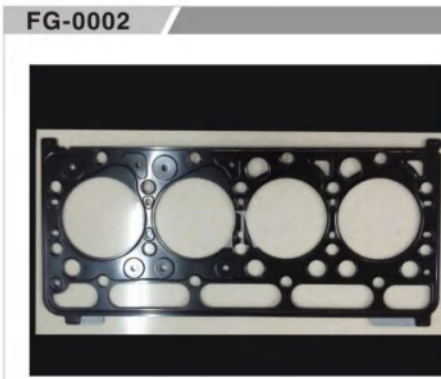

KUBOTA V2003

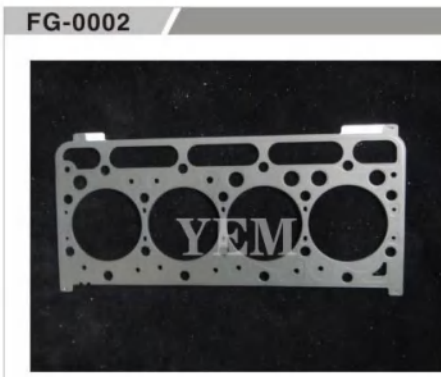

KUBOTA V2203 METAL

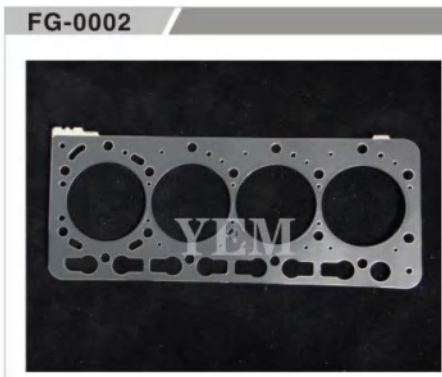

KUBOTA V3300 METAL

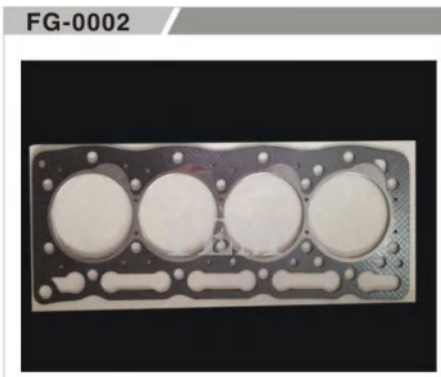

KUBOTA V1505



YANMAR 4D84-2



YANMAR 4D84-3 METAL



YANMAR 4D88 METAL

发动机件系列

发动机件系列



汽缸床 GASKET HEAD SERIES

FG-0002

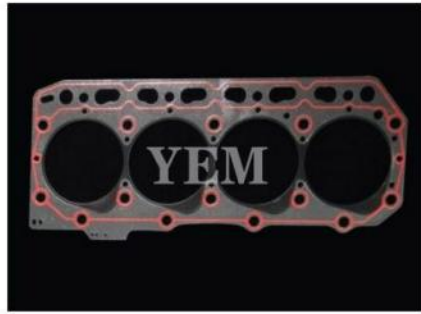

YANMAR 4D88

FG-0002



YANMAR 4TNE94 METAL

FG-0002



YANMAR 4TNE98

FG-0002



YANMAR 4TNV84T

FG-0002

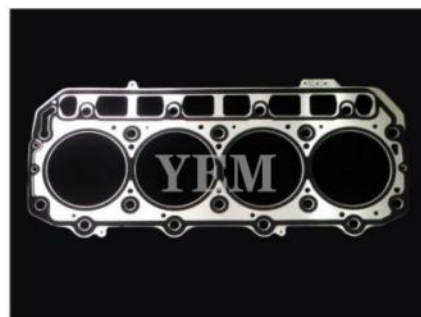

YANMAR 4TNV94 METAL

FG-0002



CUMMINS 4BT

FG-0002



CUMMINS A1700

FG-0002



CUMMINS A2300

FG-0002



CUMMINS B3,3

FG-0002

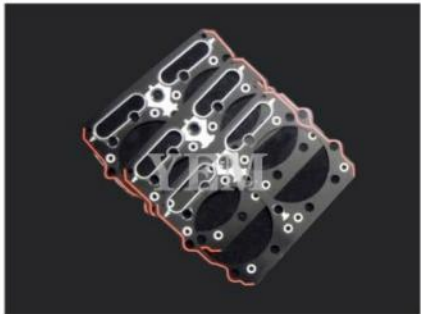

CUMMINS Nt855

FG-0002

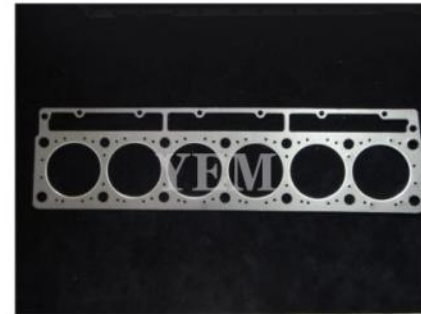

CAT 3116

FG-0002

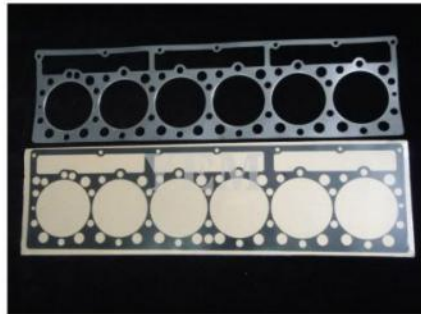

CAT 3306



汽缸床 GASKET HEAD SERIES

FG-0002



CAT 3512 三缸

FG-0002



CAT C9

FG-0002



DAEWOO D1146 metal

FG-0002

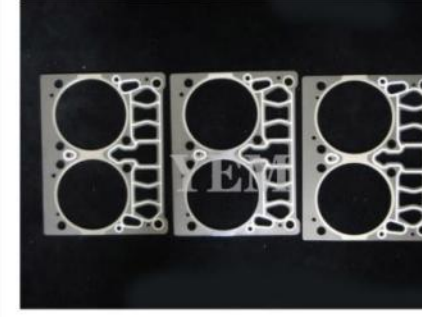

DAEWOO D1146

FG-0002



DAEWOO D2366

FG-0002

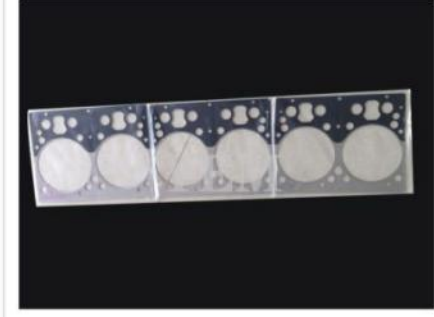

DAEWOO De08

FG-0002



DAEWOO DE12T METAL

FG-0002

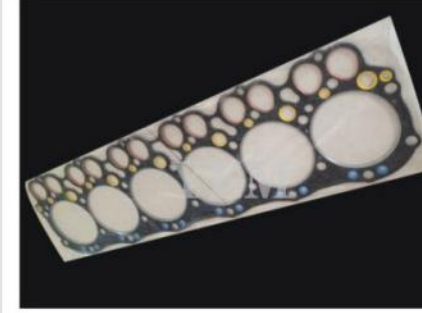

HINO H07C

FG-0002

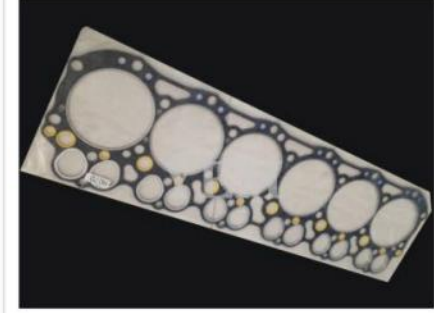

HINO H07D

FG-0002



HINO H07C

FG-0002



HINO J05

FG-0002



HINO J08C

发动机件系列

发动机件系列



汽缸床 GASKET HEAD SERIES

FG-0002

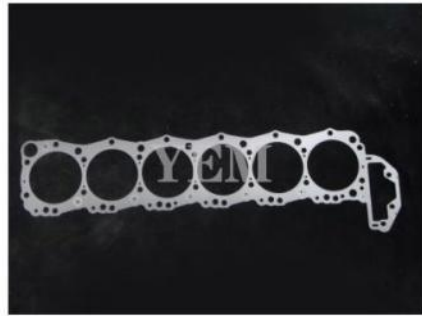

HINO J08E

FG-0002



ISUZU 4BD1 METAL

FG-0002



ISUZU 4BG1 METAL

FG-0002



ISUZU 4HKI

FG-0002



ISUZU 4JB1

FG-0002



ISUZU 4JG1

FG-0002



ISUZU 4JJ1 METAL

FG-0002



ISUZU 4LE2 METAL

FG-0002

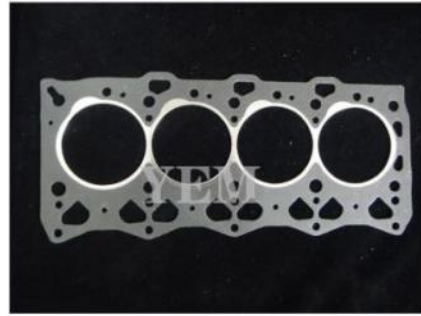

ISUZU 4LE2

FG-0002



ISUZU 4LEI METAL

FG-0002



ISUZU 6BG1 METAL

FG-0002



ISUZU 6HK1 NEW

FG-0002



ISUZU 6HK1 OLD

FG-0002



ISUZU 6SD1

FG-0002



DAEWOO D1146 metal

FG-0002



ISUZU S6D107 METAL

FG-0002



KUMATSU 4D95 METAL

FG-0002



KUMATSU 6D95 METAL

FG-0002



KUMATSU 6D105

FG-0002

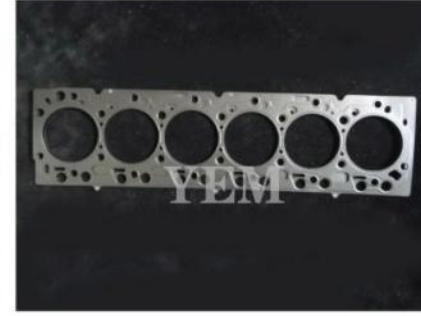

KUMATSU 6D107

FG-0002



KUMATSU 6D108

FG-0002



KUMATSU 6D125 NEW

FG-0002



KUMATSU 6D125 OLD

FG-0002



VOLVO D7D

发动机件系列

发动机件系列



汽缸床 GASKET HEAD SERIES

汽缸床 GASKET HEAD SERIES

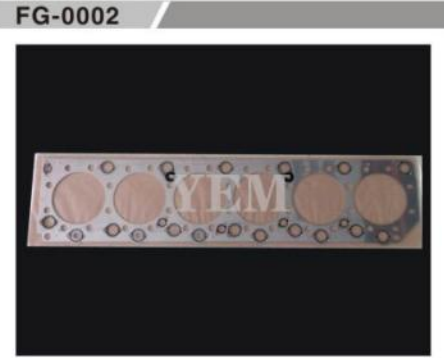

VOLVO D12D



MITSUBISHI 6D16 METAL

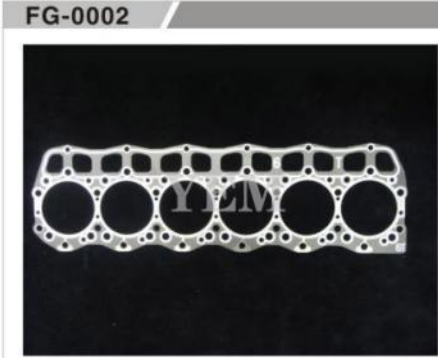

MITSUBISHI 6D16 NEW 方



MITSUBISHI 6D16 NEW 圆

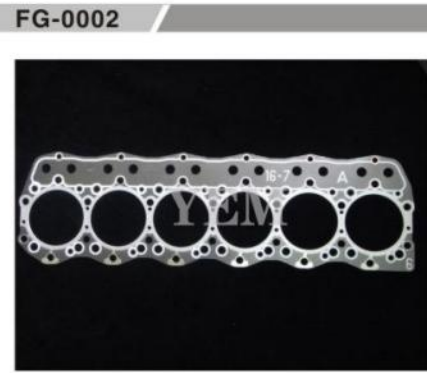

MITSUBISHI 6D16 OLD

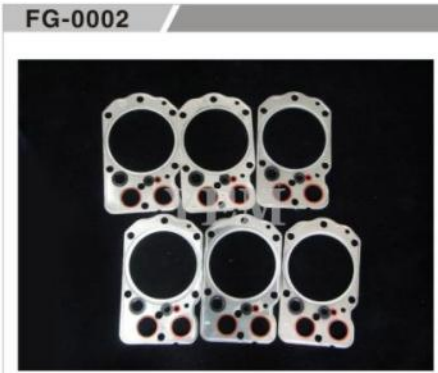

MITSUBISHI 6D22



MITSUBISHI S4K METAL



MITSUBISHI S6K



MITSUBISHI 3D84-1



MITSUBISHI 3D84-2 METAL



MITSUBISHI 3D84-3 METAL



HINO J08C



MITSUBISHI 4D120



MITSUBISHI 4D130



MITSUBISHI 4M40

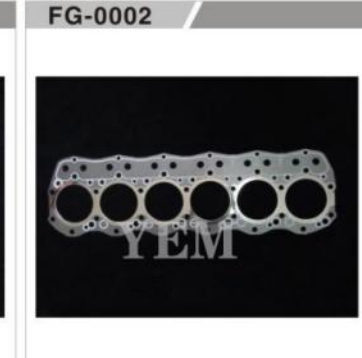

MITSUBISHI 6D14 NEW



MITSUBISHI 6D14 OLD



MITSUBISHI 6D15 NEW 方



MITSUBISHI 6D15 NEW 圆



MITSUBISHI 6D15 OLD



MITSUBISHI S4F



MITSUBISHI S4L



MITSUBISHI S4S METAL



MITSUBISHI S4S



MITSUBISHI S6E

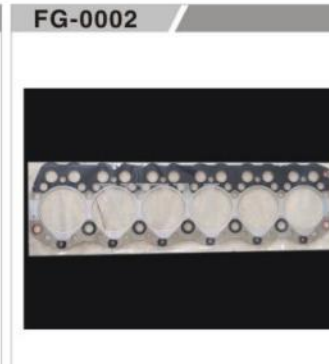

MITSUBISHI S6S METAL



MITSUBISHI S6S

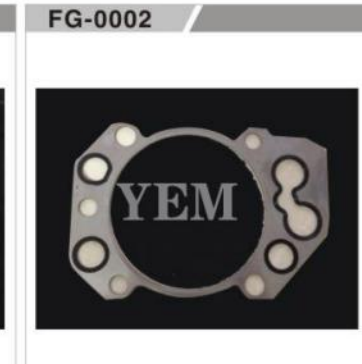

LIEBERR 914

发动机件系列

发动机件系列

发动机总成

ENGINE ASSY SERIES



发动机总成 ENGINE ASSY SERIES

Fu Ge Construction Machinery
复格工程机械



KUBOTA V2403



KUBOTA V2607

发动机件系列



KUBOTA V3800



HINO J05E

发动机件系列

发动机件系列

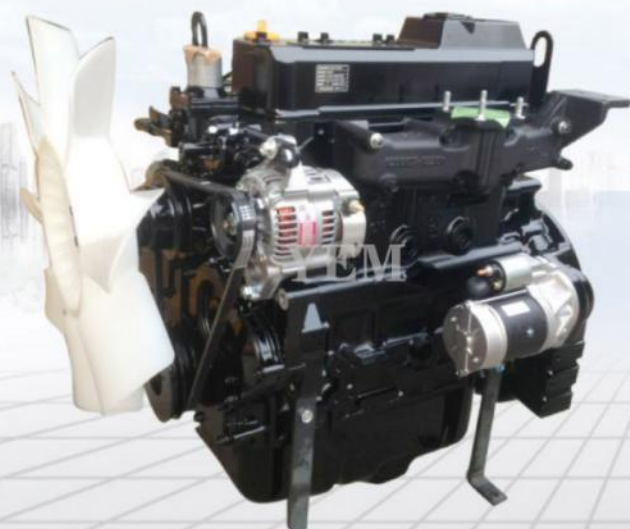

YANMAR 4TNV98

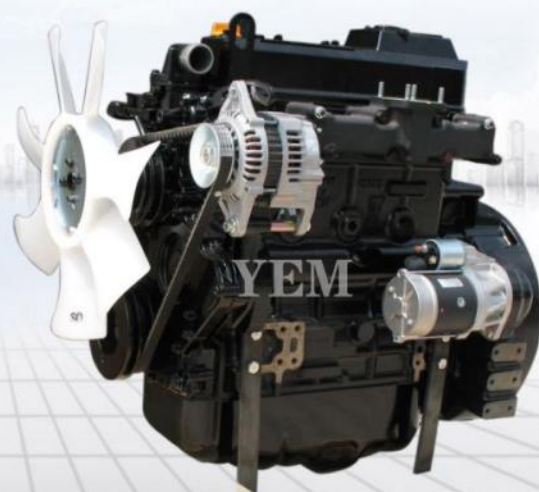

YANMAR 4TNV94

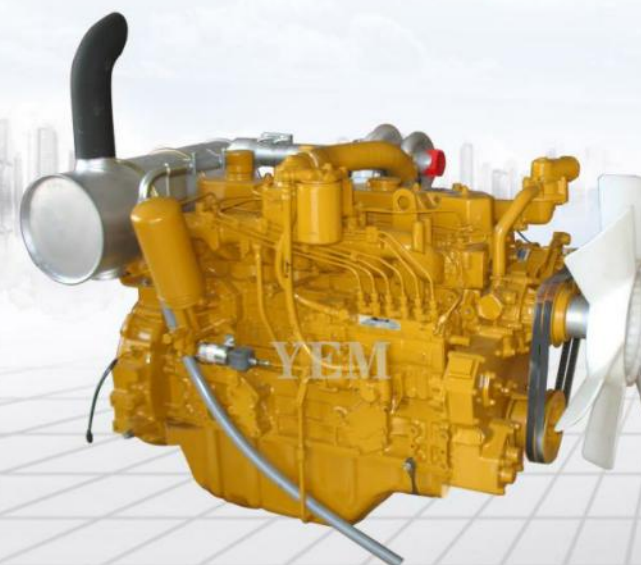

S6K E200B E320B/C



6D34

缸体系列 CYLINDER BLOCK SERIES

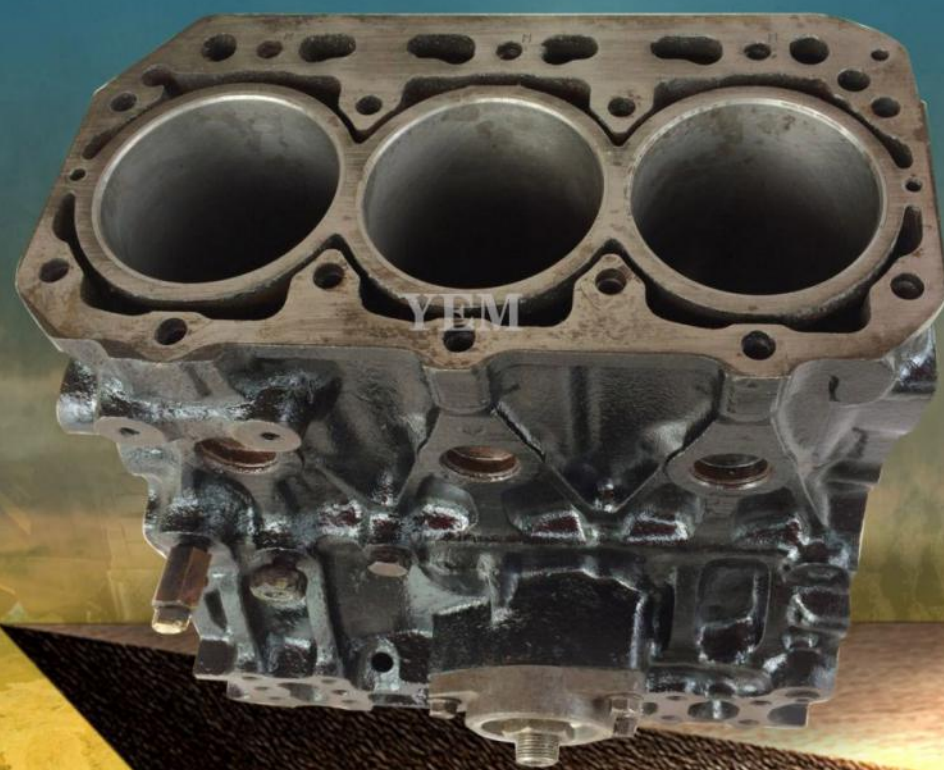

缸体系列 CYLINDER BLOCK SERIES

FG-0002



YANMAR 4TNV94

FG-0002



YANMAR 3D84

FG-0002



YANMAR 4TNV88

FG-0002



KOMATSU 4D102

FG-0002



CUMMINS 6D107

FG-0002



KOMATSU 4D95

FG-0002



KOMATSU 6D95

FG-0002



KOMATSU 6D102

发动机件系列



FG-0002



KOMATSU 6D102中缸总成

FG-0002



ISUZU 6BD1 6BG1

FG-0002



ISUZU 6HK1缸体直喷

FG-0002



ISUZU 6BG1

FG-0002



ISUZU 4BD1

FG-0002



CAT S6K

FG-0002



CAT 3306

FG-0002



DAEWOO DB58

FG-0002



6D114

缸盖系列 CYLINDER HEAD SERIES





缸盖系列 CYLINDER HEAD SERIES

FG-0002



KUBOTA V2003(1)

FG-0002

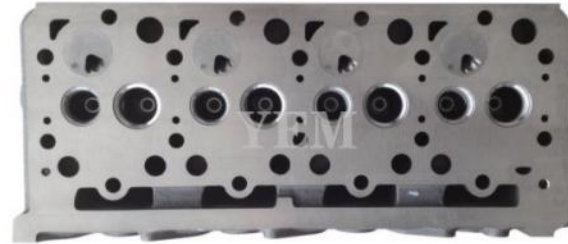

KUBOTA V2003(2)

FG-0002



KUBOTA V2403(1)

FG-0002



KUBOTA V2403(2)

FG-0002



KUBOTA D1703缸盖1A033-03043

FG-0002



KUBOTA D1703缸盖1A033-03043

FG-0002



ISUZU 6HK1缸盖 直喷

FG-0002



YANMAR 4TNV94 4TNV98

FG-0002



CUMMINS A2300 (1)

FG-0002



CUMMINS A2300 (2)

FG-0002



CUMMINS 6D107 (1)

FG-0002



CUMMINS 6D107 (2)

FG-0002

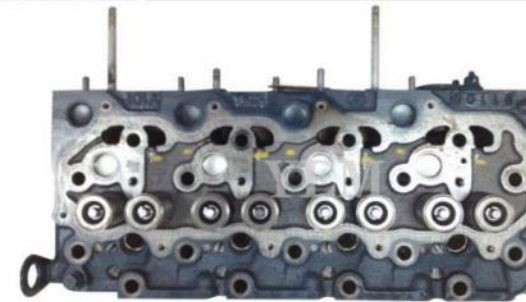

PC56-7 V2403 (1)

FG-0002



PC56-7 V2403 (2)

FG-0002



KOMATSU 4D102

FG-0002



KOMATSU 6D102

发动机件系列

发动机件系列



缸盖系列 CYLINDER HEAD SERIES

FG-0002



KOMATSU 6D114

FG-0002



KOMATSU 6D125-6

KOMATSU 6D125-5

FG-0002



ISUZU 4HK1(1)

FG-0002



ISUZU 4HK1(2)

FG-0002



ISUZU 6BD16BG1

FG-0002



ISUZU 4BT

FG-0002



ISUZU 4BD14BG1

FG-0002



ISUZU 4BD14BG1

FG-0002



CAT 3304 6R2378

FG-0002



CAT 3304 8N1188

FG-0002



CAT 3306 8N6796 直喷

FG-0002



CAT 3306PC 8N1187

FG-0002



CAT 320C

FG-0002

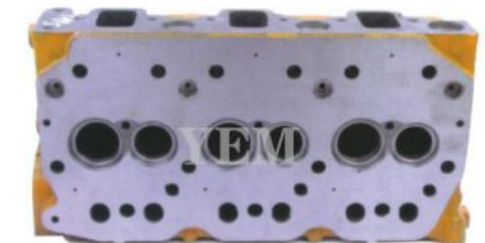

CAT S6K

FG-0002



DAEWOO DB58

FG-0002



DAEWOO D1146T

FG-0002



MITSUBISHI 4M40

FG-0002



MITSUBISHI 4M40

发动机件系列

发动机件系列

大小瓦系列 ENGINE BEARING



大小瓦系列 ENGINE BEARING

Engine Model	set NO	NDC set NO	Housing BoreMin	Length Max	Wall Thickness Max	材料	Pes/Eng
CUMMINS							
4BT	3901170	R-CU	74.02	31.00	1.980	CU	8
	3802010	M-AL+K-AL	88.02	28.90	2.456	AL	9+1
6BT	3901170	R-CU	74.02	31.00	1.980	CU	12
	3802070	M-AL+K-CU	88.02	28.90	2.456	AL	13+1
6BT5.9	3901170	R-CU	74.02	31.00	1.980	CU	12
	3802070		88.02	28.90	2.456	AL	13+1
6CT8.3	3901430	CU	81.00	38.00	2.500	CU	12
	3802210/ 3945917	M+K-AL	105.00	34.00	3.500	AL	13+1
		K-AL	105.00	43.00	3.500	AL	1
6CT8.3	3901430	CU	81.00	38.00	2.500	CU	12
	3802210/ 3945917	M+K-AL	105.00	34.00	3.500	AL	13+1
		K-CU	105.00	43.00	3.500	AL	1
NH220	203670	CU	83.13	50.18	1.850	CU	12
	3801260	CU	120.65	41.10	3.130	CU	6
	3801260	CU	120.65	54.00	3.130	CU	6
	3801260	CU	120.65	59.00	3.130	CU	2
NH250	203660	R-CU	83.0	43.8	1.855	CU	
NT855	214950	CU	84.24	44.23	2.407	CU	12
	3801260	CU	120.65	37.80	3.130	CU	6
	3801260	CU	120.65	50.50	3.130	CU	6
	3801260	CU	120.65	55.60	3.130	CU	2
NT855-N	214950	CU	84.24	44.23	2.407	CU	12
	3801260	CU	120.65	37.80	3.130	CU	6
	3801260	CU	120.65	50.50	3.130	CU	6
NH14-R	3801260	CU	120.65	55.60	3.130	CU	2
	3055145	CU	94.02	48.4	2.400	CU	12
	205840	CU	108.01	56.13	3.165	CU	12
K19·K6	AR12270	CU	148.46	46.08	4.345	CU	10
		CU	148.46	39.73	4.345	CU	4
		CU	148.46	39.73	4.345	CU	4
K19-K19 K6-K6	205840	CU	108.01	56.13	3.165	CU	12
	AR12270	CU	148.46	46.08	4.345	CU	10
		CU	148.46	39.73	4.345	CU	4
VTA28	AR4220	CU	154.84	51.41	4.300	CU	4
		CU	154.84	41.65	4.300	CU	8
		CU	154.84	54.35	4.300	CU	2
	200600	CU	101.66	46.10	3.175	CU	24
VTA28-VTA28	AR4220	CU	154.84	51.41	4.300	CU	4
		CU	154.84	41.65	4.300	CU	8
		CU	154.84	54.35	4.300	CU	2
	200600	CU	101.66	46.10	3.175	CU	24
K38	3047390	CU	114.36	52.71	3.156	CU	24
	AR12250	CU	175.02	55.90	4.325	CU	10
		CU	175.02	52.75	4.325	CU	4
KV50	3047390		114.36	52.71	3.156	CU	32
	3018210		175.02	55.90	4.325	CU	14
			175.02	52.75	4.325	CU	4
LT10,M11	3801150		122.01	36.57	3.945	CU	14
	3016760		84.01	42.16	2.437	CU	12
LT10-10 M11-11	3801150		122.01	36.57	3.945	CU	14
	3016760		84.01	42.16	2.473	CU	12



大小瓦系列 ENGINE BEARING

Engine Model	set NO	NDC set NO	Housing BoreMin	Length Max	Wall Thickness Max	材料	Pes/Eng
CATERPILLAR							
S6K							
3204	8N6308		74.73	32.00	2.407		2
	1W0312		94.20	29.80	2.595		2
	1W0311		94.20	29.80	2.595		2
3204	8N6308		74.73	32.00	2.407		16
	4W8093		94.20	25.40	2.604		6
	4W8092		94.20	25.40	2.604		4
3208	7E7894		74.73	25.70	2.407		16
	4W8092		94.20	25.40	2.604		8
	4W8091		94.20	25.40	2.604		1
3116	4W8091	K	94.20	31.80	2.604		1
	7W9415		75.01	33.80	2.465		12
	7W9414		95.02	31.80	2.440		6
	7W9416		95.02	31.80	2.440		1
3306	7W9416	K	95.02	37.83	2.440		1
	7W9413		95.02	31.80	2.440		6
	8N8220		82.55	38.20	3.139		12
D379 G379	8N8224		96.93	28.70	3.988		14
	8N7769		136.78	47.30	4.846		16
3406	8N7764		161.87	54.10	7.854		10
	9Y9497		103.51	38.9	3.195		2
	4W5492		129.9	41.8	4.579		2
DAEWOO							
DB58		R	95.02	31.00	2.473	CU	16
		M	111.02	30.50	3.472	CU	8
		K	111.02	37.80	3.472	CU	2
D-2366		M	102.02	35.00	3.092	CU	14
		R	89.03	32.00	3.110	CU	12
D-1146		M	90.02	33.00	3.100	CU	14
		R	76.00	31.00	2.000	CU	12
YANMAR							
3TNE84		M				CU	10
		R				CU	8
4D88		M	54.00	20.00	2.000	CU	10
		R	51.00	20.00	1.490	CU	8
4TNE94		M				CU	14
4TNV98		R				CU	12
VOLVO							
TD60,61/TD50	VPM91862	MB8130K7				CU	14
	VPR436	RB8130K6				CU	12
TD70,71	VPR410	RB8140K6				CU	12
	VPM91292	MB8140K7				CU	14
THD101G						CU	14
						CU	12
TD120,121,122,123	VPR91435	RB8160K6				CU	12
	VPR91902	RB8161K6				CU	12
	VPM91436	MB8160K7				CU	14
TW731						CU	14
						CU	12
TD100,101	VPR91901	RB8151K6				CU	12
	VPM91293	MB8150K7				CU	14
	VPR266	RB8150K6				CU	12

发动机件系列



大小瓦系列 ENGINE BEARING

Engine Model	set NO	NDC set NO	Housing BoreMin	Length Max	Wall Thickness Max	材料	Pes/Eng
KOMATSU							
4D92	M856K	6140-21-80	75.02	25.00	2.471	CU	10
	R886K	6140-31-30	64.02	25.00	1.982	CU	8
4D94	M407H	6142-22-801	75.02	25.00	2.471	CU	10
	R403H	6140-31-304	64.02	25.00	1.982	CU	8
4D94E			69.03	23.00	2.000	CU	10
			61.01	22.90	1.500	CU	8
4D95	M888K		74.00	25.00	1.970	CU	10
	R888KS		61.00	25.00	1.980	CU	8
4D105-1	M865K	MS-2601GP	91.02	30.13	2.995	CU	10
	R886K	CB-2601GP	70.02	33.13	2.005	CU	8
4D105-3	M858K	6130-21-80	88.02	32.13	2.995	CU	4
	M858K	6130-21-80	88.02	26.63	2.995	CU	6
	R858K	6130-31-30	70.00	37.14	2.005	CU	8
4D120	M852K	MS-1067GP	102.02	50.00	3.625	CU	10
	R852K	CB-1067GP	81.02	50.00	3.125	CU	8
6D95L	M890K	6204-21-8100	74.00	25.00	1.970	CU	14
	R890K	6207-31-3300	61.00	25.00	1.980	CU	12
	R891K		61.00	25.00	1.980	CU	12
6D102			74.02	31.00	1.980	CU	12
			88.02	28.90	2.456	CU	14
6D105/S6D105 6D110/S6D110 SAD110	M865K	MS-2601GP	91.02	30.13	2.995	CU	14
	R886K	CB-2601GP	70.02	33.13	2.005	CU	12
6D108	M859K		101.00	30.00	2.990	CU	14
	R859K		73.81	33.10	1.991	CU	12
6D125/S6S125 SA6D125	M892K		116.02	34.10	3.000	CU	14
	R892K		85.00	40.10	2.510	CU	12
6D155 S6D155 SA6D155	M878K	MS-1127GP	132.02	74.00	3.480	CU	4
			132.02	48.10	3.480	CU	10
	R878K	CB-1127GP	109.00	61.10	3.490	CU	12
6D130	M880K		120.63	59.20	3.140	CU	2
			120.63	54.10	3.140	CU	6
			120.63	41.40	3.140	CU	6
S6D140	R880K		83.12	50.30	1.850	CU	12
	M895K	6210-21-8010	127.00	40.13	3.500	CU	14
6D170	R895K	6210-31-3041	95.00	46.13	2.500	CU	12
	M897K	6162-23-8210	148.00	50.00	3.962	CU	14
	R897K	6162-23-3040	115.00	58.00	3.471	CU	12

发动机件系列



大小瓦系列 ENGINE BEARING

Engine Model	set NO	NDC set NO	Housing BoreMin	Length Max	Wall Thickness Max	材料	Pes/Eng
ISUZU							
6BD1	M4027K		85.019	27.80	2.530	CU	14
6BB1	M4036K		81.00	27.83	2.525	CU	14
6BF1	M4029K		85.019	26.80	2.518	CU	14
6BG1	R4036K		68.015	29.90	2.013	CU	12
4BD1	M4640K		85.018	26.80	2.518	CU	10
4BD1-T 4	M4641K		85.019	26.80	2.518	CU	10
BD2	M4631K		81.00	27.83	2.525	CU	10
4BG1	R4634K		68.00	29.90	2.010	CU	8
DA120	M4007K		82.02	44.05	3.515	CU	14
	R4003K		70.02	37.40	3.013	CU	12
DA640	M4007K		82.02	44.05	3.515	CU	14
	R4007K		72.00	37.40	2.513	CU	12
4BA1 4BB1	M4634K		81.00	27.83	2.525	CU	10
4BC2 4BE1	M4631K		81.00	27.83	2.525	CU	10
	R4634K		68.00	29.90	2.010	CU	8
C221 C240	M4525K		74.00	30.63	2.017	CU	4
			74.00	21.53	2.017	CU	4
			74.00	36.13	2.017	CU	2
	R4536K		56.00	21.53	1.508	CU	8
6HE1 6HF1	R4000K		70.00	30.40	2.013	CU	12
6HK1	M4000K		87.00	27.33	2.518	CU	14
4HF1	R4547K		70.00	30.40	2.013	CU	8
	M4547K		87.00	27.33	2.518	CU	10
4JA1 4JB1	M4651A		74.00	23.03	2.006	AL	10
	M4650A		64.00	23.03	2.004	AL	10
	R4650A		56.00	25.50	1.513	AL	8
6SD1		MS-1618GP	96.02	27.63	3.013	CU	14
		CB-1635GP	85.00	32.63	2.513	CU	12
6RB1		MS-1613GP	106.00	34.00	3.010	CU	10
			106.00	55.00	3.010	CU	2
			106.00	49.50	3.010	CU	2
		CB-1613GP	94.00	42.50	3.011	CU	12
E120	M4035K	MS-1154GP	106.00	34.00	3.010	CU	10
			106.00	55.00	3.010	CU	2
			106.00	49.50	3.010	CU	2
	R4035K	CB-1154GP	94.00	42.50	3.011	CU	12
10PA1	MP4038K	6+6 V1	102.97	28.73	3.013	CU	2
	RP4038K	10+10 V1	83.98	26.13	3.013	CU	2
10PD1	MP4040K	6+6 V1	109.97	27.73	2.513	CU	2
	RP4040K	10+10 V1	86.98	25.63	2.513	CU	2

发动机件系列



大小瓦系列 ENGINE BEARING

Engine Model	set NO	NDC set NO	Housing BoreMin	Length Max	Wall Thickness Max	材料	Pes/Eng
HINO							
EF100	M1127K		111.00	34.00	3.010	CU	10
	R1127K		89.02	32.70	2.497	CU	16
EF550 EF750	M123K		116.02	35.00	3.007	CU	10
	R123K		89.03	32.70	2.497	CU	16
EF350 EF500	M1128K		111.00	35.00	3.007	CU	10
EF700	R1127K		89.02	32.70	2.497	CU	16
EH700	M1149K		79.00	28.00	2.490	CU	8
EH500			79.00	35.00	2.490	CU	2
EH300			79.00	32.00	2.490	CU	4
EH100	R1140K		69.00	33.52	2.000	CU	12
HO6C	M1108K	MS-2108GP	86.40	32.00	2.602	CU	6
HO7C			86.40	28.40	2.602	CU	8
HO6B	R108K	CB-2111GP	69.02	33.00	1.991	CU	12
Ek100	M1106K		96.00	40.00	3.000	CU	14
EK200	R1106K		89.02	40.60	2.500	CU	12
Eb100	M1120K		101.02	44.00	3.000	CU	4
EB200			101.02	34.00	3.000	CU	8
EB300			101.02	64.00	3.000	CU	2
EB400	R1120K		81.02	46.00	3.000	CU	12
Em100	M1143K	MS-2103GP	96.00	34.00	3.010	CU	14
EP100-T	R138K	CB-2106GP	80.02	32.00	2.502	CU	12
EL100		MS-2103GP	96.00	34.00	3.010	CU	14
		CB-2103GP	77.03	32.00	2.002	CU	12
WO6D	M216H/M133K	MS-2109GP	78.00	25.10	2.493	CU	14
WO6DT	R216H	CB-2109GP	66.00	28.10	1.997	CU	12
HO7D	M1108K	MS-2108GP	86.40	32.00	2.602	CU	6
			86.40	28.40	2.602	CU	8
	R108K	CB-2115GP	69.00	25.15	1.997	CU	12
NISSAN							
Nd6 NE6	M3333K		96.00	28.00	3.018	CU	12
			96.00	43.00	3.018	CU	2
	R3310K		74.00	35.00	2.015	CU	12
PD6 PE6 PP6H	M3307K		106.00	35.00	3.018	CU	12
			106.00	55.00	3.018	CU	2
	R3307K		84.00	41.00	2.012	CU	12
RD8 RF8 RE8	MP3320K		116.00	31.00	3.018	CU	10
	RP3320K		88.98	39.20	2.015	CU	16
Ed30	M324K	MS-1180GP	80.00	28.00	1.995	CU	10
ED33 FD35	R3026K	GP-2801GP	66.00	32.00	1.998	CU	8
	R3023K	GP-1122GP	64.00	34.00	1.998	CU	8
LD23	R2026		57.00	25.00	1.497	CU	8
	M2026		66.66	20.00	1.830	CU	8
			66.66	22.00	1.830	CU	2
BD30 ED33	M3035K		75.00	26.00	2.013	CU	10
	R3030K		59.93	26.10	1.525	CU	8
ED6 FD6 FD6T	M3327K		80.00	26.00	1.995	CU	14
	R3327K		65.99	32.00	1.998	CU	12
FE6 FE6-T	M3329K		83.00	26.00	2.500	CU	14
	R3329K		69.00	32.00	2.000	CU	12
SD20 SD25	M3020K		75.00	32.13	2.013	CU	6
	R3020K		56.00	26.13	1.513	CU	8
T23 T25	M3035K		75.00	26.00	2.013	CU	10
T27 T27-T	R3035K		55.98	26.10	1.513	CU	8
	R3036K		59.98	26.10	1.513	CU	8

发动机件系列



大小瓦系列 ENGINE BEARING

Engine Model	set NO	NDC set NO	Housing BoreMin	Length Max	Wall Thickness Max	材料	Pes/Eng
mitsubishi							
4D30	M6029K	MS-1807GP	82.00	27.10	2.002	CU	10
	6029K	CB-1807GP	64.00	33.10	2.002	CU	8
4D34	M6029K	MS-1807GP	82.00	27.10	2.002	CU	10
		CB-1830GP	69.02	33.13	2.000	CU	8
6D31	M6331K	MS-1808GP	82.00	27.10	2.002	CU	14
	R6331K	CB-1808GP	64.00	33.10	2.002	CU	12
6D34	M6331K	MS-1808GP	82.00	27.10	2.002	CU	14
	R6333 K	CB-1830GP	69.02	33.13	2.000	CU	12
8DC8	M6314K	M1-1147GP	106.02	31.10	3.010	CU	10
	R6317K	CB-1073GP	95.02	37.60	2.510	CU	16
8DC8NEW	M6314K	M1-1147GP	106.02	31.10	3.010	CU	10
	R6317K	C1-1147GP	95.02	37.60	2.510	CU	16
8DC9	M6314K	M1-1147GP	106.02	31.10	3.010	CU	10
	R6314K	CB-1804GP	90.00	37.63	3.010	CU	16
6D14	M6320K	MS-1145GP	85.02	29.00	2.500	CU	14
	R6321K	CB-1820GP	69.02	34.00	2.000	CU	12
S4E		M1-1826GP	79.00	31.13	1.985	CU	10
		C1-1826GP	62.02	34.13	1.995	CU	8
S6K	MP624K	M1-1833GP	95.02	27.10	2.490	CU	14
	RP624K	C1-1833GP	64.02	29.60	2.000	CU	12
4M40	M7800K	MS-1832GP	72.02	22.10	1.990	CU	10
	R7800K	CB-1832GP	58.00	27.60	1.992	CU	8
4D55	M7277A	MS-1131A	70.00	32.00	1.990	CU	10
	R7270A	CB-1131A	56.00	25.10	1.493	CU	8
6D22	R115H	CB-1803GP	90.02	44.00	3.000	CU	12
	M115H	MS-1162GP	106.02	31.00	3.000	CU	14
4DQ5/4QE1	M116H	K	69.02	52.00	1.990	CU	2
		M	69.02	32.13	1.990	CU	4
	R116H	R	61.02	30.13	1.500	CU	8
4DR5	M109H		74.02	28.13	2.000	CU	10
	R109H	RP134H	62.02	32.13	2.000	CU	8
S6A	MP626K	M	138.00	44.00	3.600	CU	14
	RP626K	R	111.00	46.00	3.230	CU	12
S6B	MP627K	M	122.30	39.50	3.490	CU	14
	RP627K	R	95.02	42.50	2.490	CU	12
S6AMP		M	96.00	31.10	3.005	CU	14
		R	74.00	38.90	2.005	CU	12
S12N		M	147.11	55.00	3.465	CU	14
		R	124.15	49.60	2.980	CU	12
6DB1			96.00	49.20	3.000	CU	4
		MS-1036GP	96.00	31.20	3.000	CU	8
			96.00	56.20	3.000	CU	2
		CB-1037GP	81.00	41.20	3.007	CU	12

FIY WHEEL SERIES

飞轮齿圈系列



型号	参数	型号	参数	型号	参数	型号	参数
4M40	120T	4BT	137T	S6K	127T	4HK1	129T
S4F	110T	4BT3.9	159T	S4K	127T	6HK1	140T
4D31	110T	6BT5.9	173T	320C	127T	6BD1	129T
4D32	110T	6CT8.3	158T	320D	127T	6BG1	129T
4D84	116T	4TNV94	114T	6D31	129T	DB58	129T
4JB1	108T	4TNV98	114T	6D34	129T	6D108	148T
4BD1	128T	4LE2	108T	6D14	129T	6D125	148T挖掘机
4BG1	128T	6D102	127T	6D15	129T	6D125	137T推土机
4D95	110T	6D107	127T	6D16	129T	VOLVO210	129T
4D102	137T					VOLVO290	129T

气门系列

VALVES SERIES



气门导管系列

VALVE GUIDE



座圈系列

VALVE SEAT



KUBOTA	YANMAR	KOMATSU	ISUZU	CAT	MITSUBISHI
Z482	3TNE68	4D94	3LD1	S4K-T	S4F
Z852	3D87	4D95	4LE1	S6K-T	S4E
Z602	4D82	S6D95-5/6	4LE2	3066	4M40
D722	4D84	S6D102	C240	C6.4	4D31T
D750	4D84-1	S6D105	4JB1	C7	4D34T
D782	4D84-2	S4D105	4JG2/4JG1	C-9	6D31T
D850	4D84-3	S6D107	4JJ1	C9	6D34T
D902	4TNE88/4TNV88	S6D108	4HK1	3116	6D14
D905	4TNV92	S6D110	4BD1	3126	6D15
D950	4TNV94/4TNE94	4D120	6BD1	3204	6D16
D1005	4TNV98/4TNE98	S6D125	4BG1	3306	6D14T
D1105	4TNV106	4D130	6BG1-3/-4	3406	6D15T
D1302		6D140	6HK1直喷		6D16T
D1305	CUMMINS	SA6D155	6HK1电喷	VOLVO	6D22
V1503	A2300	S6D170	6SD1	D4D	6D24
V1505	B3.3		6WG1直喷	D6D/D6E	
D1503	6BT5.9	HINO	6WG1电喷	D7D	NISSAN
D1703	QSB5.9	W04D		D12D	BD30
D1803	QSB6.7	W06D	DAEWOO		PF6T
V2003	6CT	H06C	DB58	LIEBHERR	RD8
V2203	LT10	H06CT	D1146	R914	FE6
V2403	M11	H07C	DE08	R924	FD6
D1803	NH220	H07D	D2366	R934	NE6
V3300	QSX15	J08E	DE12T	R944	RF8
V3600	N14	J08C			QD32
V3800	NTA855	J05E			
V2607	KT19				
V3307					

止推片系列

THRUST WASHER SERIES



凸轮轴瓦系列

CAMSHAFT BUSHING SERIES



发动机件系列

发动机件系列

KUBOTA	YANMAR	KOMATSU	ISUZU	CAT	mitsubishi
Z482	3TNE68	4D94	3LD1	S4K-T	S4F
Z852	3D87	4D95	4LE1	S6K-T	S4E
Z602	4D82	S6D95-5/6	4LE2	3066	4M40
D722	4D84	S6D102	C240	C6.4	4D31T
D750	4D84-1	S6D105	4JB1	C7	4D34T
D782	4D84-2	S4D105	4JG2/4JG1	C-9	6D31T
D850	4D84-3	S6D107	4JJ1	C9	6D34T
D902	4TNE88/4TNV88	S6D108	4HK1	3116	6D14
D905	4TNV92	S6D110	4BD1	3126	6D15
D950	4TNV94/4TNE94	4D120	6BD1	3204	6D16
D1005	4TNV98/4TNE98	S6D125	4BG1	3306	6D14T
D1105	4TNV106	4D130	6BG1-3/-4	3406	6D15T
D1302		6D140	6HK1直喷		6D16T
D1305	CUMMINS	SA6D155	6HK1电喷	VOLVO	6D22
V1503	A2300	S6D170	6SD1	D4D	6D24
V1505	B3.3		6WG1直喷	D6D/D6E	
D1503	6BT5.9	HINO	6WG1电喷	D7D	NISSAN
D1703	QSB5.9	W04D		D12D	BD30
D1803	QSB6.7	W06D	DAEWOO		PF6T
V2003	6CT	H06C	DB58	LIEBHERR	RD8
V2203	LT10	H06CT	D1146	R914	FE6
V2403	M11	H07C	DE08	R924	FD6
D1803	NH220	H07D	D2366	R934	NE6
V3300	QSX15	J08E	DE12T	R944	RF8
V3600	N14	J08C			QD32
V3800	NTA855	J05E			
V2607	KT19				
V3307					

KUBOTA	YANMAR	KOMATSU	ISUZU	CAT	mitsubishi
Z482	3TNE68	4D94	3LD1	S4K-T	S4F
Z852	3D87	4D95	4LE1	S6K-T	S4E
Z602	4D82	S6D95-5/6	4LE2	3066	4M40
D722	4D84	S6D102	C240	C6.4	4D31T
D750	4D84-1	S6D105	4JB1	C7	4D34T
D782	4D84-2	S4D105	4JG2/4JG1	C-9	6D31T
D850	4D84-3	S6D107	4JJ1	C9	6D34T
D902	4TNE88/4TNV88	S6D108	4HK1	3116	6D14
D905	4TNV92	S6D110	4BD1	3126	6D15
D950	4TNV94/4TNE94	4D120	6BD1	3204	6D16
D1005	4TNV98/4TNE98	S6D125	4BG1	3306	6D14T
D1105	4TNV106	4D130	6BG1-3/-4	3406	6D15T
D1302		6D140	6HK1直喷		6D16T
D1305	CUMMINS	SA6D155	6HK1电喷	VOLVO	6D22
V1503	A2300	S6D170	6SD1	D4D	6D24
V1505	B3.3		6WG1直喷	D6D/D6E	
D1503	6BT5.9	HINO	6WG1电喷	D7D	NISSAN
D1703	QSB5.9	W04D		D12D	BD30
D1803	QSB6.7	W06D	DAEWOO		PF6T
V2003	6CT	H06C	DB58	LIEBHERR	RD8
V2203	LT10	H06CT	D1146	R914	FE6
V2403	M11	H07C	DE08	R924	FD6
D1803	NH220	H07D	D2366	R934	NE6
V3300	QSX15	J08E	DE12T	R944	RF8
V3600	N14	J08C			QD32
V3800	NTA855	J05E			
V2607	KT19				
V3307					



曲轴系列 CRANKSHAFT SERIES

曲轴系列 CRANKSHAFT SERIES

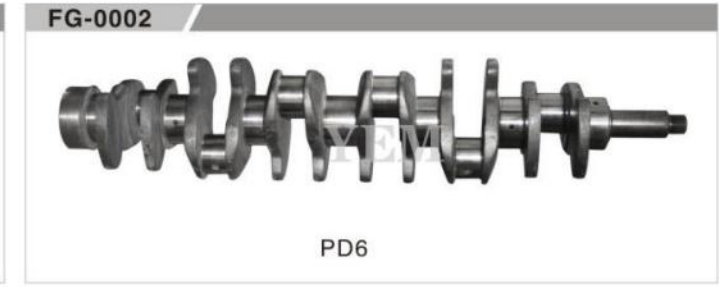
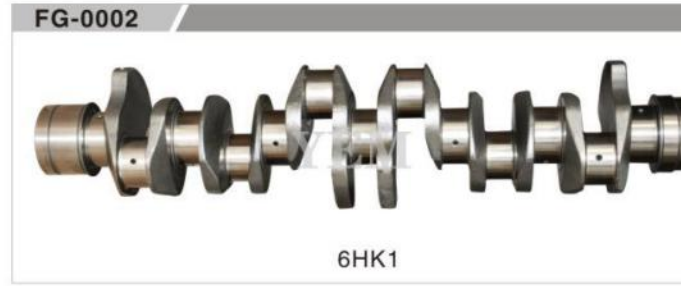
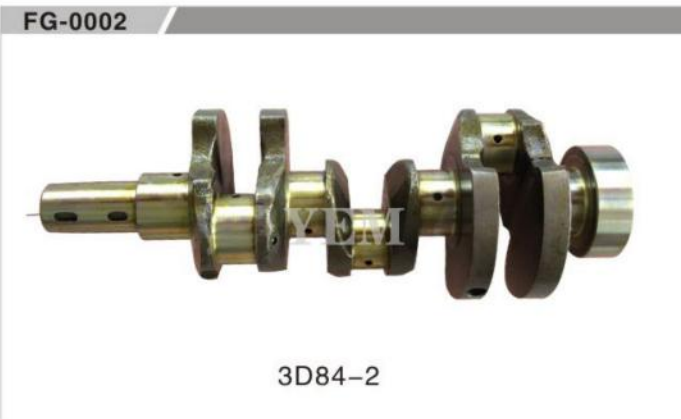

发动机件系列

发动机件系列



曲轴系列 CRANKSHAFT SERIES

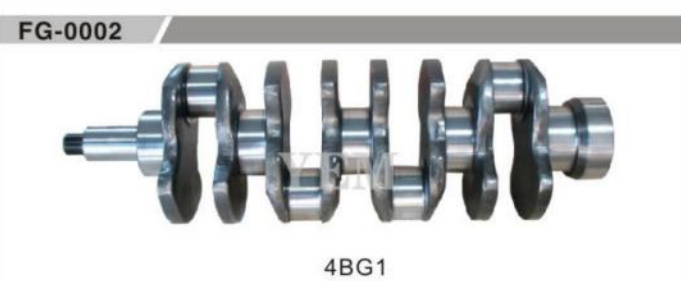
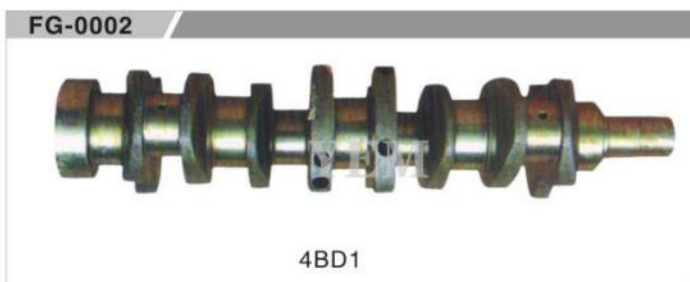
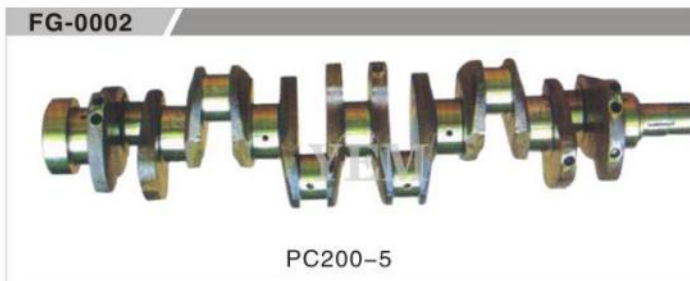

曲轴系列 CRANKSHAFT SERIES

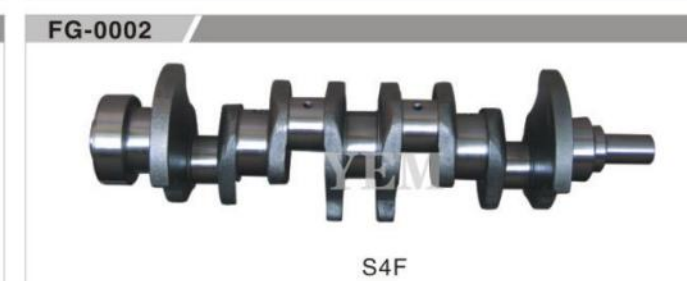
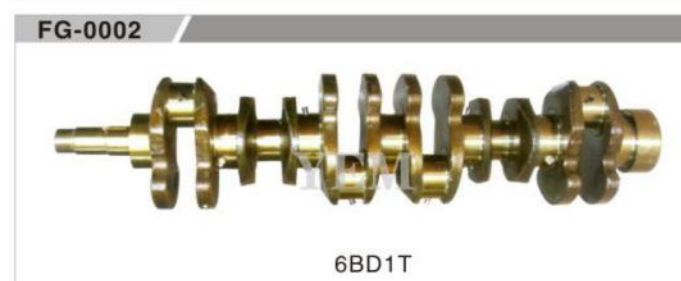
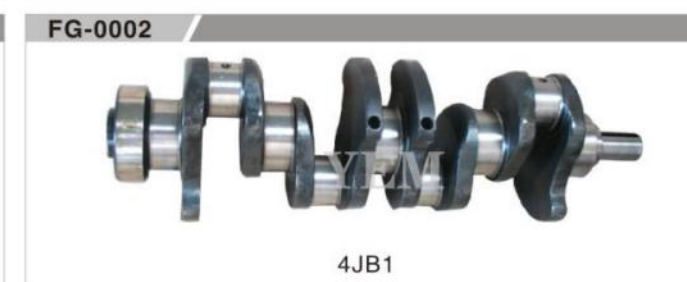
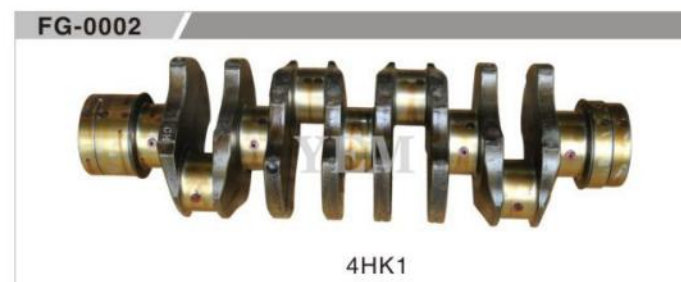

发动机件系列

发动机件系列



曲轴系列 CRANKSHAFT SERIES

连杆系列 CON-ROD SERIES

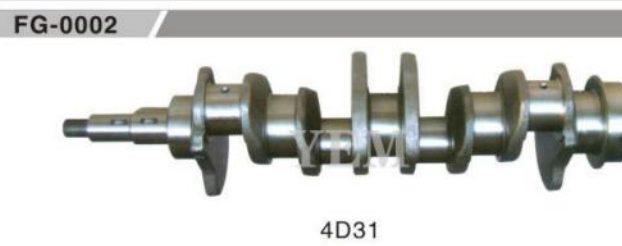
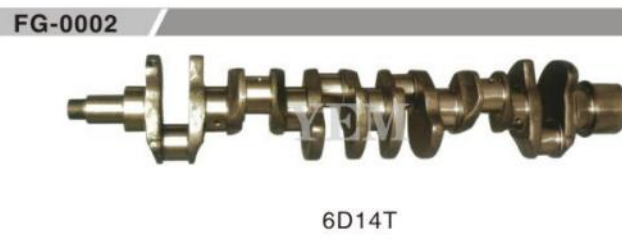
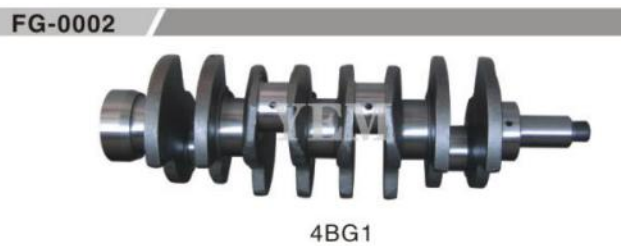







发动机件系列

发动机件系列













连杆系列 CON-ROD SERIES

<p>FG-0002</p>  <p>6SD1五十铃连杆 Isuzu Connecting Rod</p>	<p>FG-0002</p>  <p>6RB1五十铃连杆 Isuzu Connecting Rod</p>	<p>FG-0002</p>  <p>6BB1五十铃连杆 Isuzu Connecting Rod</p>	<p>FG-0002</p>  <p>6BD1五十铃连杆 Isuzu Connecting Rod</p>
<p>FG-0002</p>  <p>S6K卡特连杆 Mitsubishi Connecting Rod</p>	<p>FG-0002</p>  <p>卡特3306连杆 8N1720</p>	<p>FG-0002</p>  <p>卡特 8N1729-5</p>	<p>FG-0002</p>  <p>D1146大字连杆 Daewoo Connecting Rod</p>
<p>FG-0002</p>  <p>D2366大字连杆 Daewoo Connecting Rod</p>	<p>FG-0002</p>  <p>DB58大字连杆 Daewoo Connecting Rod</p>	<p>FG-0002</p>  <p>6D14(斜口)三菱连杆 Mitsubishi Connecting Rod</p>	<p>FG-0002</p>  <p>6D14(平口)三菱连杆 Mitsubishi Connecting Rod</p>
<p>FG-0002</p>  <p>6D22三菱连杆 Mitsubishi Connecting Rod</p>	<p>FG-0002</p>  <p>6D31三菱连杆 Mitsubishi Connecting Rod</p>	<p>FG-0002</p>  <p>三菱 8DC9</p>	<p>FG-0002</p>  <p>斯太尔</p>

发动机件系列



凸轮轴系列 CAMSHAFT SERIES

 <p>FG-165 V2403 凸轮轴总成 Camshaft assy</p>	 <p>FG-165 4TNV88 凸轮轴总成 Camshaft assy</p>
 <p>FG-164 6BT 凸轮轴 Camshaft</p>	
 <p>FG-155 6BD1 凸轮轴 Camshaft</p>	
 <p>FG-163 DH220-5 凸轮轴 Camshaft</p>	
 <p>FG-150 S6K 凸轮轴 Camshaft</p>	
 <p>FG-151 6D31 凸轮轴 Camshaft</p>	
 <p>FG-161 6D31 凸轮轴 Camshaft</p>	
 <p>FG-152 PC200-3 S6D105 凸轮轴 Camshaft</p>	
 <p>FG-153 PC200-5 6D95 凸轮轴 Camshaft</p>	

发动机件系列



凸轮轴系列 CAMSHAFT SERIES



FG-154
S6D102 凸轮轴 Camshaft



FG-156
PC200-6 6D102 凸轮轴 Camshaft



FG-157
6B31 新凸轮轴 Camshaft



FG-159
S4D95 凸轮轴 Camshaft



FG-158
4D102 凸轮轴 Camshaft



FG-160
S6D125 凸轮轴 Camshaft



FG-162
S6D95 凸轮轴 Camshaft



FG-166 NH220 NT855通用



FG-167 S6D155

发动机配件 ENGINE PARTS SERIES



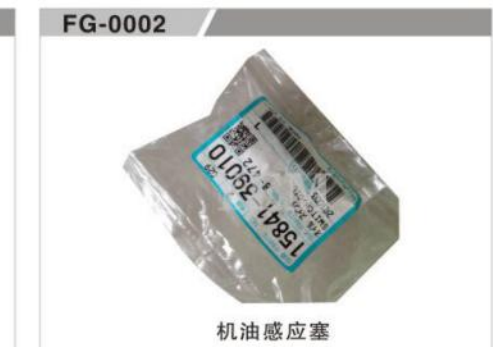
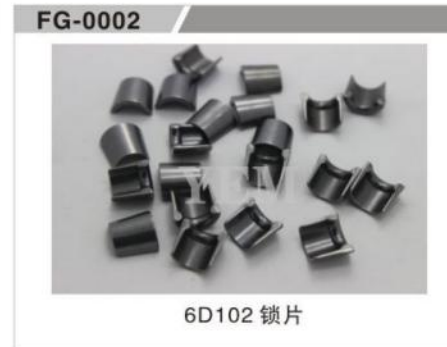

发动机件系列

















发动机件系列



水泵 water pump



水泵 WATER PUMP

<p>FG-002</p>  <p>D782 1G820-73030 1G820-73035</p>	<p>FG-002</p>  <p>1A021-73030直接替换 16412-73030 最长款</p>	<p>FG-002</p>  <p>V1505 16251-73034 16241-73034</p>	<p>FG-002</p>  <p>V2403-7 15521-73033 6675652 铸铁</p>
<p>FG-002</p>  <p>V2403 1K321-73030 forklift truck</p>	<p>FG-002</p>  <p>V2607 1J700-73030</p>	<p>FG-002</p>  <p>V3300 V3800 1C010-73030 6680852</p>	<p>FG-002</p>  <p>V3307 1G772-73032</p>
<p>FG-002</p>  <p>V2203 1A051-73032 6684865 不带管</p>	<p>FG-002</p>  <p>D722方 19883-73030 15881-73033</p>	<p>FG-002</p>  <p>D722圆 19883-73030 15881-73033</p>	<p>FG-002</p>  <p>V1902 D1402 通用于02系列 直接替换15521-73039 15521-73033, 15521-73035</p>
<p>FG-002</p>  <p>V2403 1G730-73032 6684865 带管</p>	<p>FG-002</p>  <p>YANMAR 3D82</p>	<p>FG-002</p>  <p>NISSAN PD6 PE6 21008-96107</p>	<p>FG-002</p>  <p>MITSUBISHI K4N</p>

泵系列



水泵 WATER PUMP



水泵 WATER PUMP

泵系列

泵系列

<p>FG-0002</p>  <p>PC400-6 S6D125E 6151-62-1102</p>	<p>FG-0002</p>  <p>PC300-6 6D108 8槽 6222-63-1200</p>	<p>FG-0002</p>  <p>6D125 PC300-3 PC400-5 6151-61-1101</p>	<p>FG-0002</p>  <p>PC200-6 (6D95) 6209-61-1100 6206-61-1505</p>
<p>FG-0002</p>  <p>PC200-1/2 6D105 6136-61-1102</p>	<p>FG-0002</p>  <p>PC400-1 6D110 6138-61-1860</p>	<p>FG-0002</p>  <p>PC60 S4D95 6209-61-1100</p>	<p>FG-0002</p>  <p>PC200-3 6D105 6136-62-1102</p>
<p>FG-0002</p>  <p>PC300-6 6D108 4槽 6221-61-1102</p>	<p>FG-0002</p>  <p>6D95 PC200-5 6206-61-1102</p>	<p>FG-0002</p>  <p>R220-5 6D102 PC200-6/7/8 6BT5.9 3389145 6735-61-1501</p>	<p>FG-0002</p>  <p>4D95L 6121-61-1610</p>
<p>FG-0002</p>  <p>S6D155 D155A1 6124-61-1004</p>	<p>FG-0002</p>  <p>D355C1 SA6D155 6127-61-1008</p>	<p>FG-0002</p>  <p>6SD1 EX300-5</p>	<p>FG-0002</p>  <p>6134-61-1410 S4D105-5</p>
<p>FG-0002</p>  <p>6122-61-1440 S6D140</p>	<p>FG-0002</p>  <p>6162-63-1012 S6D170</p>	<p>FG-0002</p>  <p>S6D140 6212-61-1203</p>	<p>FG-0002</p>  <p>4D94</p>

<p>FG-0002</p>  <p>4D94E</p>	<p>FG-0002</p>  <p>6D95L 6206-61-1505</p>	<p>FG-0002</p>  <p>16110-79025 IDZ</p>	<p>FG-0002</p>  <p>6SD1 EX300-2/3</p>
<p>FG-0002</p>  <p>EX200-2 住友200 6孔</p>	<p>FG-0002</p>  <p>4BD1 SH120 EX120 SK120</p>	<p>FG-0002</p>  <p>EX200-1 住友280 4孔</p>	<p>FG-0002</p>  <p>BD30 EX60/70</p>
<p>FG-0002</p>  <p>EX220-1/2/3 H06CT</p>	<p>FG-0002</p>  <p>EX60</p>	<p>FG-0002</p>  <p>6BG1 EX200-5</p>	<p>FG-0002</p>  <p>E55 EX55</p>
<p>FG-0002</p>  <p>4BG1T</p>	<p>FG-0002</p>  <p>1-13610015-1 6QA1</p>	<p>FG-0002</p>  <p>1-13610857-0 6RB1T</p>	<p>FG-0002</p>  <p>8-94376855-0 NPR 4BG1</p>
<p>FG-0002</p>  <p>1-87810663-0 E120</p>	<p>FG-0002</p>  <p>ZX330 6HK1</p>	<p>FG-0002</p>  <p>6BG1T</p>	<p>FG-0002</p>  <p>E320C 3066T 178-6633</p>



水泵 WATER PUMP



水泵 WATER PUMP

泵系列

FG-0002 E3208 2W1225	FG-0002 E3204 2W1223	FG-0002 E330C 卡特水泵	FG-0002 E307B Sh60 4M40
FG-0002 E325B/C 3116	FG-0002 E3126 224-3255	FG-0002 S6K	FG-0002 3306T 2P0662
FG-0002 3006T 2P0661	FG-0002 3306T 2W8002	FG-0002 3006T 2W8001	FG-0002 2W8003 3306T
FG-0002 4N7498 D8L	FG-0002 176-7000 C12	FG-0002 C4.4	FG-0002 1615718 3412
FG-0002 8-94104755-0 C190	FG-0002 康明斯R300-5 6CT.8.3	FG-0002 R300-5 6CT8.3	FG-0002 NH220 康明斯 6685-61-1024

泵系列

FG-0002 NT855 3055747	FG-0002 6BT	FG-0002 M11 3073693	FG-0002 NH220-3945361C
FG-0002 R200-5老 R200 三菱	FG-0002 R200-5新 R210-5 三菱	FG-0002 6D14新 6D15新 HD800	FG-0002 6D14旧 6D15旧 HD800
FG-0002 HD1250 6D22 机油	FG-0002 6D22 黄油	FG-0002 HD700-5 SK200-3/5/6 6D316D34新款	FG-0002 4JB1五十铃
FG-0002 6D16 SK220-3	FG-0002 4D31 HD250 HD400 HD450	FG-0002 6D31老款	FG-0002 HD250 S4F 4D31
FG-0002 9-13610069 DA220	FG-0002 8-14600169-0 TCM C240	FG-0002 8-94376832 C240	FG-0002 8-94396670-0 6HE1T



水泵 WATER PUMP

 FG-0002 1-12365475 DH640	 FG-0002 8-98038845-0 SH200-5 4HK1	 FG-0002 8-98022822-1 ZAIX200-3 4HK1T	 FG-0002 25100-72000 8DC91
 FG-0002 31645-02021 4DR5	 FG-0002 34545-00013 S4E	 FG-0002 34545-10017 S4S	 FG-0002 32B45-10031 S6S
 FG-0002 30045-60067 6DB10	 FG-0002 34545-0013A S4F	 FG-0002 DL	 FG-0002 04204095 2012
 FG-0002 04206747 1013	 FG-0002 T4131E025 1006TAG	 FG-0002 S4F	 FG-0002 DA640
 FG-0002 4D34	 FG-0002 6D16	 FG-0002 DH220-3	 FG-0002 DH220-5 DB58T

泵系列



水泵 WATER PUMP

 FG-0002 DH280-3 D2366	 FG-0002 DE12TIS	 FG-0002 DH300-5	 FG-0002 洋马4TNV94
 FG-0002 洋马4D89-2	 FG-0002 洋马4TNE88	 FG-0002 VOLVO210/290 沃尔沃水泵	 FG-0002 VOLVO
 FG-0002 VOLVO	 FG-0002 8-97028590-0 4JG2	 FG-0002 V32 4G54	 FG-0002 16100-00705 2J 六孔
 FG-0002 16100-49655 5M	 FG-0002 16100-71200 1Z.2Z.11Z	 FG-0002 16100-78701-71 7F 2Z	 FG-0002 16100-21470 2J 五孔
 FG-0002 2Z	 FG-0002 7F 2Z	 FG-0002 16100-49836 H20-11	 FG-0002 21010-19010 FD46T

泵系列



水泵 WATER PUMP

机油泵 OIL PUMP

<p>FG-0002</p>  <p>尼桑 2100896107 PD6</p>	<p>FG-0002</p>  <p>21010-37526 SD25</p>	<p>FG-0002</p>  <p>H20</p>	<p>FG-0002</p>  <p>尼桑 2108-96073 PE6</p>
<p>FG-0002</p>  <p>日野 16100-2522 W04D</p>	<p>FG-0002</p>  <p>日野 16100-2531 W06E</p>	<p>FG-0002</p>  <p>16100-2952 EF750</p>	<p>FG-0002</p>  <p>16100-3122 EK100</p>
<p>FG-0002</p>  <p>16100-3264 H07CT</p>	<p>FG-0002</p>  <p>EP100</p>	<p>FG-0002</p>  <p>J08E</p>	<p>FG-0002</p>  <p>DSC12</p>
<p>FG-0002</p>  <p>SCANIA</p>	<p>FG-0002</p>  <p>11-7319 11-0506-0001-09</p>	<p>FG-0002</p>  <p>04259548 DF416M1013ECP</p>	<p>FG-0002</p>  <p>T4131011C 1004TAG</p>
<p>FG-0002</p>  <p>04259548 DF416M1013ECP</p>	<p>FG-0002</p>  <p>T4131011C 1004TAG</p>	<p>FG-0002</p>  <p>178-6539 34335-23010</p>	

机油泵 OIL PUMP

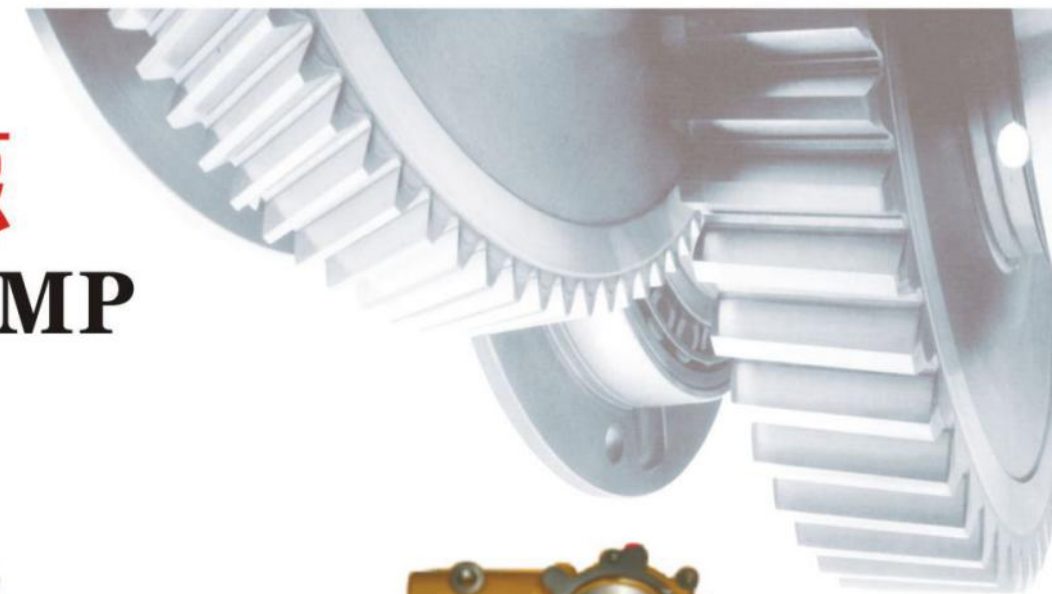

E320机油泵
E320C不带中冷



E320C机油泵
带中冷



E320 E320B E320C
178-6539 34335-23010



E320B 5I-7948

泵系列

泵系列























机油泵 OIL PUMP

<p>FG-0002</p>  <p>KUBOTA D782机油泵16851-35012</p>	<p>FG-0002</p>  <p>KUBOTA V1505 16241-35070</p>	<p>FG-0002</p>  <p>KUBOTA V2403机油泵15471-35013</p>	
<p>FG-0002</p>  <p>KUBOTA V2607 1J700-35480 1J700-35490</p>	<p>FG-0002</p>  <p>KUBOTA V3307 1G772-35070</p>	<p>FG-0002</p>  <p>KUBOTA V3800 1C010-35070</p>	
<p>FG-0002</p>  <p>YANMAR 4TNV88 119802-32120 119802-32111</p>	<p>FG-0002</p>  <p>YANMAR 4TNV88机油泵129407-32000</p>	<p>FG-0002</p>  <p>VOLVO D6D机油泵</p>	
<p>FG-0002</p>  <p>VOLVO D7D机油泵</p>	<p>FG-0002</p>  <p>MITSUBISHI S4S</p>	<p>FG-0002</p>  <p>MITSUBISHI S6S</p>	<p>FG-0002</p>  <p>DAEWOO DE12T机油泵 65.05100-6023S</p>

泵系列



机油泵 OIL PUMP

<p>FG-0002</p>  <p>6204-53-1100 直齿 发动机号：4D95 适用机型：PC60-7</p>	<p>FG-0002</p>  <p>6209-51-1101 斜齿 发动机号：S6D95, SA6D95, SAA6D95 适用机型：PC200-6</p>	<p>FG-0002</p>  <p>6207-51-1100 斜齿 发动机号：S4D95, S6D95 适用机型：PC100-5, PC120-5</p>	<p>FG-0002</p>  <p>6209-51-1100 斜齿 发动机号：S6D95, SA6D95 适用机型：PC200-5</p>
<p>FG-0002</p>  <p>6CTA8-3 3930338</p>	<p>FG-0002</p>  <p>6CTAA8-3 3966840</p>	<p>FG-0002</p>  <p>6BT</p>	<p>FG-0002</p>  <p>4BT</p>
<p>FG-0002</p>  <p>PC300-6 S6D108-1</p>	<p>FG-0002</p>  <p>PC300-5 6D108</p>	<p>FG-0002</p>  <p>S6D125</p>	<p>FG-0002</p>  <p>6D125</p>
<p>FG-0002</p>  <p>3306</p>	<p>FG-0002</p>  <p>PC200-3 S6D105</p>	<p>FG-0002</p>  <p>6BG1</p>	<p>FG-0002</p>  <p>HD450/4D31 ME014603</p>
<p>FG-0002</p>  <p>6BD1T</p>	<p>FG-0002</p>  <p>4BD1</p>	<p>FG-0002</p>  <p>4BG1</p>	<p>FG-0002</p>  <p>K19 3047549</p>

泵系列



机油泵 OIL PUMP

 FG-0002 PC200-8 04204095 2012	 FG-0002 Nt855 3821572	 FG-0002 N14 3803698	 FG-0002 6D31 ME-084586
 FG-0002 K11	 FG-0002 Nh855	 FG-0002 6D155	 FG-0002 6HK1
 FG-0002 PC200-1	 FG-0002 6D140	 FG-0002 H06CT	 FG-0002 4D94E
 FG-0002 6211-51-1000 6D140	 FG-0002 6D102	 FG-0002 B4 3937027	 FG-0002 H06CT
 FG-0002 6162-53-1012 S6D170	 FG-0002 6620-51-1021 Nh220	 FG-0002 5M7864 3306T	 FG-0002 2P9239 3306T

泵系列



机油泵 OIL PUMP

 FG-0002 4W2448 3306T	 FG-0002 2W8625 3116D1	 FG-0002 3412	 FG-0002 E120 8-97033182-2
 FG-0002 Da640 3945361B	 FG-0002 4HF1 8-97147338-0	 FG-0002 E120 8-97033182-2	 FG-0002 GD22T
 FG-0002 6DB10	 FG-0002 6D14T	 FG-0002 6D31T	 FG-0002 6D31 65.06500-61240
 FG-0002 4D31 16100-87394-88	 FG-0002 15010-46G05 TD2T	 FG-0002 15010-P6015 PD6	 FG-0002
 FG-0002 4JB1	 FG-0002 51-7686 34335-12070 24齿	 FG-0002 51-7558 34335-03031 9齿	 FG-0002 E320C 机油泵盖

泵系列



输油泵 FUEL INJECTION PUMP

<p>FG-0002</p>  <p>6D102 手油泵 105220-5960</p>	<p>FG-0002</p>  <p>PC400-6 手油泵 105217-6030</p>	<p>FG-0002</p>  <p>320C 手油泵</p>	
<p>FG-0002</p>  <p>6BG1 手油泵 H5750198-0 1-15750192-0</p>	<p>FG-0002</p>  <p>6BD1 手油泵</p>	<p>FG-0002</p>  <p>6HK1 手油泵 1-15750130-0</p>	
<p>FG-0002</p>  <p>S6K 手油泵</p>	<p>FG-0002</p>  <p>4HF1 手油泵</p>	<p>FG-0002</p>  <p>6D17 手油泵</p>	<p>FG-0002</p>  <p>DH220-5 手油泵</p>
<p>FG-0002</p>  <p>DH300-5 手油泵 105207-1520</p>	<p>FG-0002</p>  <p>6D34 手油泵</p>	<p>FG-0002</p>  <p>8DC9 手油泵</p>	<p>FG-0002</p>  <p>8DC91 手油泵</p>
<p>FG-0002</p>  <p>6D114 3936316 大孔</p>	<p>FG-0002</p>  <p>6D114 3936318 小孔</p>	<p>FG-0002</p>  <p>3904374/3917998 枪式</p>	<p>FG-0002</p> 

泵系列

泵系列

输油泵 FUEL INJECTION PUMP



<p>FG-0002</p>  <p>PC400-7</p>	<p>FG-0002</p>  <p>1W1698 1W568</p>	<p>FG-0002</p>  <p>E330C 1W1700</p>	<p>FG-0002</p>  <p>PC240-8 6754-71-1012 6754-71-7200</p>
<p>FG-0002</p>  <p>VOLVO210输油泵</p>	<p>FG-0002</p>  <p>洋马 YANMAM 4D84</p>	<p>FG-0002</p>  <p>6BT5.9 烟斗 3904574/3904374</p>	<p>FG-0002</p>  <p>CAT 20MM 2W2605 183-2823</p>
<p>FG-0002</p>  <p>14MM</p>	<p>FG-0002</p>  <p>CAT3304 12MM 137-5541</p>	<p>FG-0002</p>  <p>E320C 10MM 4W0788 1052508</p>	<p>FG-0002</p>  <p>铝 铁 2447222020 手柄</p>
<p>FG-0002</p>  <p>CAT 9H2256</p>	<p>FG-0002</p>  <p>VOLVO 210 21584586</p>	<p>FG-0002</p>  <p>VOLVO 210B 20917999 20518337</p>	<p>FG-0002</p>  <p>VOLVO手压输油泵</p>

增压器

TURBOCHARGER



增压器 TURBOCHARGER

<p>FG-0002</p>  <p>康明斯系列 H1C 4BT</p>	<p>FG-0002</p>  <p>康明斯系列 H1E 6CT</p>	<p>FG-0002</p>  <p>康明斯系列 WH1E-1 6CT</p>	<p>FG-0002</p>  <p>康明斯系列 HX40W 6BT</p>	<p>FG-0002</p>  <p>康明斯系列 HX40W 6D114</p>
<p>FG-0002</p>  <p>康明斯系列 H2D LT-10</p>	<p>FG-0002</p>  <p>康明斯系列 Hx55 M11</p>	<p>FG-0002</p>  <p>康明斯系列 T-46 NT855</p>	<p>FG-0002</p>  <p>康明斯系列 H25A K19</p>	<p>FG-0002</p>  <p>康明斯系列 Hx80 K38</p>
<p>FG-0002</p>  <p>康明斯系列 K50 K19</p>	<p>FG-0002</p>  <p>康明斯系列 Ht60 M4</p>	<p>FG-0002</p>  <p>小松系列 KTR110 S6D140</p>	<p>FG-0002</p>  <p>小松系列 KTR110 S6D170</p>	<p>FG-0002</p>  <p>小松系列 TA4532 S6D125</p>
<p>FG-0002</p>  <p>小松系列 S400 S6D125E-3</p>	<p>FG-0002</p>  <p>小松系列 T04B53 S6D105</p>	<p>FG-0002</p>  <p>小松系列 T04B59 S6D95</p>	<p>FG-0002</p>  <p>小松系列 T04E S6D108</p>	<p>FG-0002</p>  <p>小松系列 TB4130 S6D125</p>
<p>FG-0002</p>  <p>小松系列 TA3103 S4D95</p>	<p>FG-0002</p>  <p>小松系列 TA3137 S4D95</p>	<p>FG-0002</p>  <p>小松系列 HX35W S6D10ZE</p>	<p>FG-0002</p>  <p>小松系列 TD04-L-106 4BT</p>	<p>FG-0002</p>  <p>小松系列 HX30 S6D95</p>

增压器系列



增压器 TURBOCHARGER

增压器 TURBOCHARGER

增压器系列

增压器系列

FG-0002 小松系列 HX35 S6D102E	FG-0002 小松系列 HX30W 4BT	FG-0002 小松系列 KTR130 D155	FG-0002 卡特系列 T04B91 3304	FG-0002 卡特系列 TD06H-16M S6K
FG-0002 卡特系列 TD06H-16M 3066	FG-0002 卡特系列 133745 3116	FG-0002 卡特系列 3LM373 3306	FG-0002 卡特系列 S310 3306	FG-0002 卡特系列 E325C 3116
FG-0002 卡特 3306	FG-0002 卡特系列 CAT330 3306	FG-0002 卡特系列 3406B	FG-0002 卡特系列 3406	FG-0002 卡特系列 S310E-080 C-9
FG-0002 卡特系列 D7G 3306	FG-0002 卡特系列	FG-0002 卡特系列 D345B	FG-0002 大字系列 DH300-7	FG-0002 大字系列 DH300-5 D1146
FG-0002 沃尔沃系列 S2B-2 210	FG-0002 日野系列 EX220-5 H07CT	FG-0002 日野系列 EX220-5 H07CT	FG-0002 日野系列 TBP430 J08C	FG-0002 日野系列 TBP430 J08C

FG-0002 日野系列 HX50W K13D	FG-0002 日野系列 Gt3576 J08E	FG-0002 日野系列 RHE8 K13C	FG-0002 日野系列 RHE9 6WGF1	FG-0002 日野系列 RHC6 T04E
FG-0002 日野系列	FG-0002 三菱系列 Td04 4D56	FG-0002 三菱系列 S1B	FG-0002 三菱系列 S6A	FG-0002 尼桑系列 Pd6 KLD85Z
FG-0002 尼桑系列 FD46	FG-0002 尼桑系列 Qd32	FG-0002 住友系列 4BD1 S120	FG-0002 住友系列 S280 6BD1	FG-0002 加藤系列 RHE6 6BG1
FG-0002 加藤系列 TD05-10A HD512	FG-0002 加藤系列 Td06 HD450	FG-0002 加藤系列 TD06-17A HD700	FG-0002 加藤系列 TD07-17C HD700-5	FG-0002 加藤系列 TD08H HD850
FG-0002 加藤系列 TD07-9 6D14	FG-0002 日立系列 RHB6 4BD1	FG-0002 日立系列 RHC7 6BD1	FG-0002 日立系列 ZAX330 6HK1	FG-0002 日立系列 RHC9 6WG1



增压器 TURBOCHARGER

增压器 TURBOCHARGER

 日立系列 RHC9 6BD1	 日立系列4HK1 J05E	 日立系列 RHC6 6BD1	 日立系列 RHE61 6BG1	 日立系列 RHC7 6SD1
 日立系列 RHEC 6SD1	 日立系列 TD08H EX300-5	 日立系列 Ta5108 6RB1	 现代系列 GT-17	 现代系列HX35W R2205
 现代系列TD04H-16	 现代系列GT17	 现代系列HX35	 现代系列 瑞丰	 现代系列GT17
 现代系列GT1749S 4D56	 现代系列HX40W D1146	 丰田系列 Ct9 HR492HT	 丰田系列 CT12B 3-G-3202	 丰田系列 Ct20 HR492HT
 神钢系列 Td041 4BD1	 神钢系列 TD06H-13M 6D34	 神钢系列 TD06H-16M 6D34	 神钢系列 SK200-8 J05E	 神钢系列 SK350-8 J08E

小松	Komatsu	
Turbo Model	Engine Model	Part No
PC60	S6D95	
PC100-1/2/3/5	S4D95	6205-81-8110
PC100-6	S4D95	
PC120-1/2/3/5	S4D95	6732-81-8102 3539803 3539846 3804963
PC120-6	S4D102	6732-81-8100
PC130-7	SAA4D95LE-3	6208-81-8100
Pc150	S6D95	
PC200-3	S6D105	6137-82-8200
PC200-5	S6D95	6207-81-8210
PC200-6	S6D95	6207-81-8311
PC220-6	S6D102	6735-81-8031/8500 3539697 3539698 3539699 3539700
PC200-7	SAA6D102E-2	6738-81-8090 4038475 4035373 4035374 4035172
PC210-7	SAA6D102E-2	
PC220-7	SAA6D102E-2	6738-81-8181/8190 3598036 4035899 4038471 4035376
PC200-8	SAA6D107E-1	
PC210-8	SAA6D107E-1	
PC220-8	SAA6D107E-1	
PC240-8	SAA6D107E-1	
PC300	S6D125	6152-81-8110
PC300-5/6	S6D108	6222-81-8210 6222-83-8171
PC300-7	S6D114	6743-81-80404038421 3597311/2 3597808 3597809/10/11
PC360-7	SAA6D114	
PC400	S6D125	6152-81-8500
PC400-5	S6D125	6152-81-8210
PC400-6	S6D125E	6152-82-8210
PC400-7	SA6D125E-3	
PC450-7	SA6D125E-3	
PC1000	6D170	6505-11-6250
D155	S6D155	6502-13-2003
D355	S6D155	6502-12-9005
KTR110	S6D140	6505-52-5410
KTR110	S6D170	6505-52-5540
D85	NT855	
WA320-3	S6D108	6222-83-8120
WA320-3	SA6D102E	6736-81-8190
WA350-1	S6D110-1A	6138-82-8201
WA380-1	S6D110-1Q	6138-82-8200
WA380-3	S6D108-1F	6222-83-818
WA380-3	SA6D114	6742-01-3110
WA380-5	S6D114-2B	6743-81-8050
WA400-1	S6D110-1J	6138-82-8201
WA420-1	S6D110-1W	6138-82-8200
WA420-3	S6D114	6742-01-5000
WA450-1	S6D125-1M	6152-81-8300

WA470-1	S6D125-1KK	6152-81-8310
WA470-3	S6D125-1AM	6152-81-8310
WA470-3	S6D125E-2	6152-81-8310
WA500-1	S6D140-1	6505-11-6474
	S6D170-1D	6505-52-5510
	SA6D170A-1Q	6162-84-8201
日立	HITACHI	
Turbo Model	Engine Model	Part No
RHB6	4BD1	8-94418-3200
TDO4	4BD1	49189-00540
TDO4	4BG1	49189-00501
EX200-1	6BD1	114400-2100
EX200-2/3	6BD1	114400-2720
EX200-5	6BG1	114400-3320
EX200-6	6BG1	114400-3770
EX220-1	HO6CT	24100-1860
EX220-5	HO7CT	24100-3340
EX220-5		24100-2252B
EX300-1	EP100	24100-1440
EX300-2/3	6SD1	114400-2961
EX300-3C	6SD1TPD-S	114400-3340
EX300-5/330-5	6SD1TQA	114400-3530
ZAX200	6BG1	114400-3770
ZAX330	6HK1	114400-3900
EX300-7	6HK1	
EX400-1	6RB1	114400-2080
EX400-3	6RB1	114400-3170
EX450-5	6RB1	114400-3360
ZAX330-3C	6SD1	114400-4380
ZAX240-3	4HK1	8973628390
ZAX250	4HK1	8973628390
ZAX450	6RB1	114400-3830
FE6	RHC6	210690 1420125613
卡特	CAT	
Turbo Model	Engine Model	Part No
E110	4D31	517585
E110B	S4K	517903
E120	6D14	517903
E120B	S4K	49168-00330
CAT225	3304	4N6858
E240	6D15	518122
E240B	3116	49168-01202
E200B	S6K	49179-00451 515015
E312B	S4K	ME518122
E320	S6K	49179-02260 ME517952
E320B	3066	49179-02300 ME518018

增压器系列

增压器系列



增压器 TURBOCHARGER

E325	3116	
E325B	3116	
E325C	3116	177-0440
E330	3306	
E330B	3306	219-1909 106-7407
E330C风冷	3306	191-5094
E330C水冷	3306	
E330D风冷	C9	
E330D水冷	C9	216-7815
E350	3306	
E950/950B	3304	4N6859
D6D	3306	6N7924
D7G	3306	4N9544
966D	3306	1W9383
D8K	D342	6N7203
D5H	3304	7N4651
D5 D333C	3306	4N8969
	3406	7C6609
	3306	219-9710
	3412	7C2485
住友	SUMITOMO	
Turbo Model	Engine Model	Part No
SH120-1	4BD1	8-94418-3200
SH120-2/3/5	4BD1	49189-00540 491789-00570 8972234280
SH200-1	6BD1	114400-2720
SH200-2	6BG1	114400-3320
SH200-3	6BG1	114400-3890
SH260	4BD1/4BG1	49185-00540
SH265	4D31-3	49178-00500
S280	6BD1	114400-1070
SH340	6BD1	114400-1070
SH300	6D22	ME158162
SH240-5	4HK1	
神钢	HITACHI	
Turbo Model	Engine Model	Part No
SK120/1/2/3	4BD1/4BG1	49189-00540
SK200-1	6D31新款	ME088488
SK200-1	6D31老款	ME088256 49179-02110
SK200-3	6D31最新款	ME088488
SK200-5	6D34螺丝	ME088840 49185-01030
SK200-6	6D34螺丝	ME441234 49185-01020
SK230-6	6D34插管	ME088865 49186-00360
SK230-6E	6D34螺丝	49185-01030
SK330-6	6D16	ME078660
SK200-8	J05E	24100-4631
SK210-8	J05E	

SK250-8	J05E	
SK260-8	JO5E	
SK330-8	J08E	
SK360-8	JO8E	
SK350-8	J08E	
加藤	KATO	
Turbo Model	Engine Model	Part No
HD450	6D14	
HD450	4D31	
HD510/512	4D31 4	
HD650	6D14	
HD700	6D15	
HD700	6D14	
HD700-5	6D31老款	
HD700-7	6D31新款	
HD800	6D14	
HD820	6D34	
HD900	6D14	
HD900	6D15	
HD1023	6D22	
HD1250	6D22	
现代	Hyundai	
Turbo Model	Engine Model	Part No
R130	4BT3.9	
R190	6CT8.3	
R200	6BT5.9大口	
R200-5/220-5	6BT5.9大口	
R210-3	6BT5.9大口	
R210-5	6D16	
R210-5	6D14	
R210-7	6BT5.9小口	
R215-7	6CT8.3	
R220-7	6BT5.9大口	
R225-7	6BT5.9	
R290-3	6CT8.3	
R300-3	6CT8.3	
R300-5	6CT8.3	
R450-3/5	L10	
大宇	DAEWOO	
Turbo Model	Engine Model	Part No
DH220-5	DB58	
DH220-7	DB58	
DH258	D1146	
DH300/-5	D1146	
DH300-7		
DH320		

增压器 TURBOCHARGER

DH330	D1146T	
DH350		
沃尔沃	VOLVO	
Turbo Model	Engine Model	Part No
EC210	D6DEAE	
EC210B	D6DEAE	
EC240	D6DEAE	
EC260		
EC290	D7DEAE2	
EC360	D108EAE2	
EC360B		
EC460	D108EAE2	
EC420		
康明斯	CUMMINS	
Turbo Model	Engine Model	Part No
TA31	4B 3.9	728001-0002
HX30W	4BT	4050220/221
H1C	4BT 3.9	3522900
HX30	4BTA	3592112 3592109
HX35	6BT	3597913 3599686 3597914
HX35	6BT	3536338 3536339 3537132 3537133 3598176 3539697 3537134 3537135 3537136 3537137
WH1C	6BT	3539428 3539429 3539956 3593089 3591122 3591123 3591124
TA3407	6BT	451567-5005
HX35W	6BT	3536313 3802694 3536321 3536971 3538868 3538626 3536977
TBP4	6BTAA	702646-5005
HIE	6CT	3802303 3802126
HX40	6CT	3533000 3533008 3533370 3533369 3535005 3536818
HX40W	6CT	4050204
WHIE	6CT	3528174
HX80	K19	3594067 3594066 3594027
H2C	L10	3594131
H2D	L10	3519092 3519095 3801489
HX50	M11	3525237 3803024
HT3B	NT	3522867
T-46	NT855	3523415
HT3B	NTC320	3026924
HX40W	QS	3522861
HY35W	ISbe	4025225 4039139
HC5A	KTA19	3593155/3597179
HC5A	KTA38	3523850 3594027
ST-50	NT855	3524451
日立 五十铃 日野	Hitachi Isuzu Hino	
Turbo Model	Engine Model	Part No
TB25	JX493ZQ	111830TC 471169-5006
TB25	JX493ZQ	1118300ADB1 471169-5002
GT22	JX493ZQ	1118300SZ 736210-5005

GT22	JX493ZQ	1118300DL 736210-5009
RHB5	4GB1	8971760801
RHB5	4JB1	8970385180/1
RHF4	4JB1	8971397243
RHF5	4JB1 2.8	8973659480
RHF6	4BD1	8944183200
TB25	NPR 3.9L	8943829000
TD04-15G	4BG1	8943675161 49189-00501
RHE7	K13C	24100-3064A
TB4154	6BD1	114400-2720
T04B83		114400-1331 465467-0005
TA5108	6RB1	114400-2080 466860-0005
T04E63		24100-3218A
TBP430		24100-3301A
TBP431	YF75	24100-3331A
HX55W		4051174 W860255956
HX50W		4027959 24100-2920A/B
GT3576	J08C	24100-3251C
	K13C	24100-2741B 2711B12 3130
三菱	Mitsubishi	
Turbo Model	Engine Model	Part No
TD04	SJ 4D56	49177-01500/1
TD04	4D56 DE	49177-01510
TD04	4D56 2.5LD DE	49177-01511
TF035	4D56	49135-02110
TF035	4M40	49135-03110
TD06-17C	6D14	49175-00418
TD06-6		ME132165 49179-00500
TD07-9	6D16	49187-00271
TD07-9	6D16	49187-01010
TD08		49174-01142
TD08		49188-01262
TD05H	Galant 2.0CP	MD168037 49178-01410
TD06-17C		49175-00418
TD06-6	4D31	ME132165 49179-00500
TD07-9	6D16	49187-00271
TD07-9	6D16	49187-01010
TD05H	Galant	MD168037 49178-01410

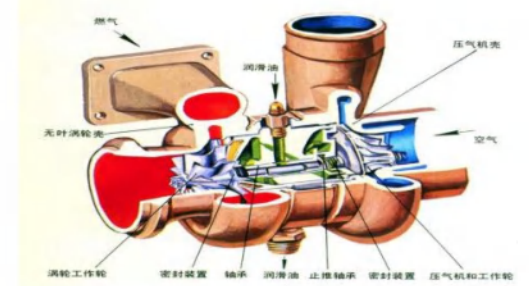

增压器系列

增压器系列



喷油嘴总成 FUEL INJECTOR ASSY



喷油嘴总成 FUEL INJECTOR ASSY



喷油嘴系列

喷油嘴系列



三偶件系列 PLUNGER/D.VALVE/NOZZIE



喷油嘴系列

Model	Engine NO.	Oil nozzles	IMPRINT NO.	Plunger	IMPRINT NO.	Delivery Valve	IMPRINT NO.
DH200-5	DH200-5	105025-1390	DLLA156SMI139A	131150-2600	A814	131160-5320	39A
DAEWOO	D1146T	105015-5670	DLLA160SN567	131152-0420	A126	131160-3620	20A
	DH280LL-3		BDLL150S308	134151-2320	P104	134110-0920	P8
HD400	三菱4D31T	105017-0100	DLLA160PN010	131152-1420	A138	131160-0420	A85
HD700-5	三菱6D31T	105017-0850	DLLA160PN085	131152-1420	A138	131110-4720	A28
HD800	三菱6D14T/15T	105015-5670	DLLA160SN567	131152-0020	A122	131110-4720	A84
HD1250	三菱6D22T	105015-5330	DLLA154SN533	13415-2920	P109	134110-4420	P34
EX200-1	五十铃6SD1T	105015-4190	DLLA154S334N419	131151-3220	A44	134110-2920	12A
EX200-2	五十铃6SD1T	105015-8210	DLLA158SN821	131151-3220	A44	134110-1920	02A
EX200-2/3	五十铃6SD1T	105015-8690	DLLA154SN869	13115-2220	A44	134110-1920	02A
EX220-5	日野H07CT	105015-9220	DLLA160SN922	131151-0620	A794	134110-5520	A36
EX220	日野H07CT	105015-7180	DLLA142SN718	130063-2020	A228	134110-3920	23A
VH181	五十铃6RB1T	105015-3520	DLLA150S384NP73	134101-1820	P6	134110-6120	P41
EX300-5	五十铃6SD1T	105025-1780	DLLA150SM178a	134153-1220	P296	134110-5320	P52
EX300-5	五十铃6SD1T	105015-9071	DLLA154SN907	134152-7220	P252	134110-5320	P52
EX300-1	日野EH700	105015-3680	DLLA154SN334NP89	131151-3920	A54	134110-4520	A26
EX300-1	日野EP100	105015-7220	DLLA154SN907	134101-9620	P78	134110-1420	P13
EX300-1	日野EP100	105015-4900	DLLA150S355N490	134101-9620	P78	134110-1420	P13
EX400-3	6RB1TPQ	105015-6660	DLLA150SN666	134153-0420	P284	134110-4220	P41
ISUZU	6BR1-MTC	105015-6660	DLLA150SN666	134151-3420	P114	134110-5320	P52

注释：所有原厂制造商之名称、型号、标志、包装、及品名只供参考

三偶件系列 PLUNGER/D.VALVE/NOZZIE



Model	Engine NO.	Oil nozzles	IMPRINT NO.	Plunger	IMPRINT NO.	Delivery Valve	IMPRINT NO.
HITACHI	日野EK100	105015-4640	DLLA154S374N464/414	134101-4020	P44/P25	134110-6320	P62
ZAX		105025-3040	DLLA149SM304	134150-4320	A831	131160-5320	39A
ZAX		105025-3270	DLLA147SM327	134154-0720	P388	134160-2920	26P
R200	现代6D16T/D6B	105015-6440	DLLA160SN644	131152-3320	A160	130010-8820	09A
R210-3	康明斯6BT5.9		DLLA145P574	9412038421	421	9418270042	0 42
R290	康明斯6CT8.3		DLLA150P115	9412270043	0 43	1418522209	209
HYUNDAI	6BT215		DLLA155P270	131150-4420	A832	131160-1020	A91
HYUNDAI	6BT215		DLLA150SN945A	131150-4420	A832	131160-1020	A91
PC120-5	S4D95L	105017-0530	DLLA152PN063	131152-4520	A174	131110-6820	A49
PC200-3	S6D105	105015-5020	DLLA142S354N502	131151-5820	A74	131110-7720	A58
				131151-6320	A794		
PC200-5	S6D95L	105017-0140	DLLA152PN063/014/009	131152-9320	A235	131110-6820	A49
PC200-5	S6D95L	105017-0090	DLLA152PN063/009/014	131152-2220	A235	131110-6820	A49
PC200-5	S6D95L	105017-0880	DLLA150PN088	131152-4020	A148	131110-6820	A49
				131152-6820	A204	131110-3920	A20
PC220-5	S6D95L	105017-0140	DLLA152PN014	131152-2220	A148	131110-6820	A49
KOMATSU	4D102E		DLLA145P606	131154-3920	A281	131110-7720	A58
PC200-6	S6D102E-1-A	0 433 171454	DLLA145P606	131154-3920	A281	131110-8020	A61
PC200-6	SA6D95L	105017-0880	DLLA150PN088	131152-3020	A157	131110-6820	A49
PC300-5/6	SA6D108	093400-6430	DLLA140P643	090150-5683	5683	090160-2440	244
PC300-5	SAD108-1	093400-5690	DLLA152P69	090150-4660	4660	090140-2020	R
PC400-3	S6D125	105015-5950	DLLA150SN595	134151-2220	P103	131110-0120	P1
				134101-9820	P80	131110-2120	P20
PC400-6	SA6D125	105015-6770	DLLA155SN677/595	134101-9820	P80	131110-8920	P88
						131110-0120	P1
PC200-7	6BTAA	105015-2910	DLLA140PN291	134115-5620	A298	131110-9020	A61
PC400-6	SA6D125E	105015-0120	DLLA145SM012	134153-3620	P317	131110-8920	P88
PC220-7	6BTAA	105015-2910	DLLA140P291	131154-5620	A298	131110-7720	A58
SUMITOMO	五十铃6BD1	105010-4190	DLLA154S334N419	131151-3220	A44	131160-1920	02A
SH280	五十铃6BG1T	105025-0290	DLLA153SM029	131153-6120	A740	131160-6520	39A
E200B		105017-0530	DLLA155PN053	131151-7320	A89	131110-6820	A49
E320	PES6-AD105B410R	105017-0530	DLLA155PN053	131153-9220	A771	131160-6320	39A
E320C		105025-0370	DLLA150SM037	131153-9120	A770	131110-8820	A69
E320C		105025-0800	DLLA160SM080	131153-9120	A770	131110-8820	A69
E320B新款	S6K-T	105017-2760	DLLA155PN276	131153-9220	A771	131150-5320	39A
E320C		105017-2760	DLLA155PN276	131153-7920	A758	131160-5320	39A
E320CL		105017-2760	DLLA155PN276	131150-3220	A821	131160-5320	39A
E320	三菱S6T	105017-1180	DLLA155PN118	131151-7320	A89	131160-2920	12A
E320		105017-1180	DLLA155PN118	131153-9220	A771	131160-5320	39A
E320		105017-0140	DLLA152PN014	131151-7320	A89	131150-2920	12A

喷油嘴系列



机油散热器盖 OIL COOLER COVER

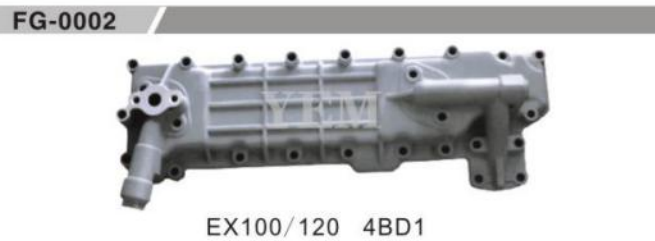
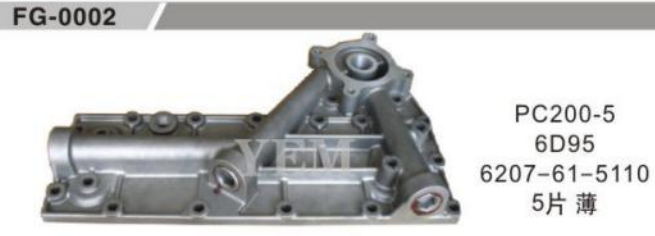

机油散热器盖 OIL COOLER COVER

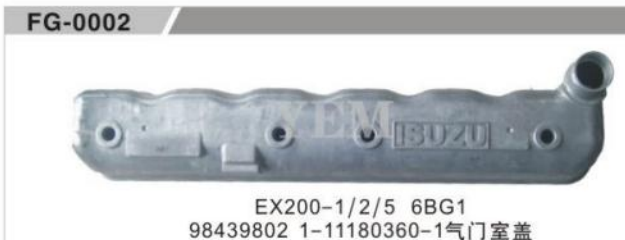
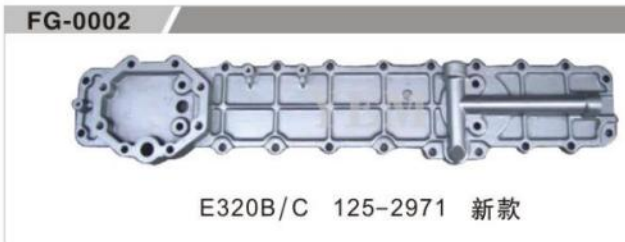
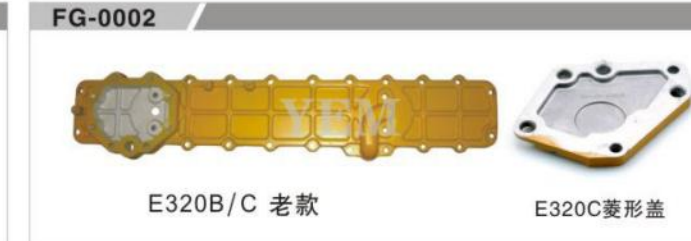
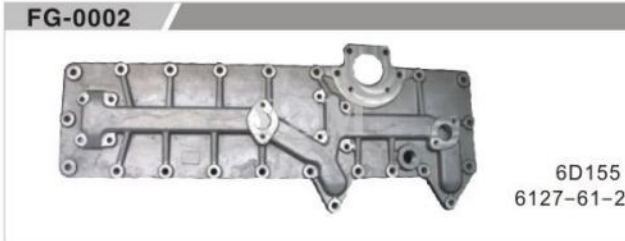

机油散热器盖

机油散热器盖



机油散热器芯 OIL COOLER CORE

FG-0002



PC200-5/6D95
600-651-1520
5P
Oil cooler core

FG-0002



PC200-3/6D105/S6K/200B
5I-7563
600-651-1412/34399-02102
4P通用 Oil cooler core

FG-0002



PC200-6/6D95
600-651-1550
7P
Oil cooler core

FG-0002



PC200-2/3
6D105 S6K 200B
600-651-1411 3P
Oil cooler core

FG-0002



PC120-6
4D102
Oil cooler core

FG-0002



PC200-6/6D102
6BT5.9
6735-61-2110/3918176
7P
Oil cooler core

FG-0002



PC300-7
6CT
Oil cooler core

FG-0002



PC300-3
PC400-3/5/6
6D125
10P
Oil cooler core

FG-0002



PC60/4D95
3P
Oil cooler core

FG-0002



PC S6D155
600-651-1161
10P
Oil cooler core

FG-0002



6D125
6150-61-9320
10P
Oil cooler core

FG-0002



E320B 5P
125-2970
Oil cooler core

FG-0002



ZAX 6BG1 5P
Oil cooler core

FG-0002



EX200-1/2 6BD1 4P
Oil cooler core

FG-0002



HD800 6D14 4P
Oil cooler core



机油散热器芯 OIL COOLER CORE

FG-0002



HD700-5 6D31 6D34新款 5P
Oil cooler core

FG-0002



6D22 5P
Oil cooler core

FG-0002



4BD1 4P
Oil cooler core

FG-0002



SH300 6D22/9P
Oil cooler core

FG-0002



康明斯
PN3023079
K19 Oil cooler core

FG-0002



康明斯
PN3627295
K38/K50 Oil cooler core

FG-0002



J08
Oil cooler core

FG-0002



J05E
Oil cooler core

FG-0002



NT855
Oil cooler core

FG-0002



VOLVO2240/290
Oil cooler core

FG-0002



6D155
Oil cooler core

FG-0002



4D31/32机油散热器芯

FG-0002



A 4W7190 4W7188
B 7N3505 7N3521M
C 2P8797 7N0110M031
D 7N0128 9M8818
E 7N0165 7S6394

机油散热器芯

机油散热器芯



起动马达 STARTING MOTOR

发电机 ALTERNATOR



起动马达系列

发电机系列

 FG-0002 YANMAR 4T98 24V/9T	 FG-0002 YANMAR 4D84 15T/PC40	 FG-0002 4TNV94 原装款 9T	 FG-0002 PC60-7/6D95(NEW) 24V/11T/4.5KW 600-813-4400
 FG-0002 KUBOTA 久保田 12V/9T/2.0KW	 FG-0002 久保田 V3008/V3300 12V/9T/2.5KW	 FG-0002 NT855 24V/3孔/11T/7.5KW	 FG-0002 CUMMINS 4B3.3 12V/9T/2.8KW
 FG-0002 CUMMINS 6BT5.9(ND) 24V/10T/4.8KW	 FG-0002 DH300-5/220-3 24V/11T/4.5KW	 FG-0002 DH200-5 ZAX200-6 210/230/240 3孔/11T	 FG-0002 4M40 24V/11T/4.5KW
 FG-0002 DH55/4JG1(24V) 12V/11T/3.5KW	 FG-0002 6BG1 电装 24V/11T/5.5KW	 FG-0002 4HK1 ZAX240-3 24V/3孔/13T/5.0KW	 FG-0002 FM12/FH12/V300 VOLVO360 6CT CUMMINS 24V/12T/5.5KW
 FG-0002 210/240/290 VOLVO 24V/12T/5.5KW	 FG-0002 BOSCH VOLVO 210 240 24V/9T	 FG-0002 P11C SK450-8	 FG-0002 6D17 24V/2孔/11T/6.0KW

 FG-0002 型号: PC60 4D95 件号: 600-821-3850 0-33000-5510 24V 15A	 FG-0002 型号: PC200-6 S6D102 件号: 600-861-3411/6410 101-211-4310 24V 25A	 FG-0002 型号: PC300 6D125 件号: 24V 25A 600-311-5720/0-33000-5880	 FG-0002 型号: EX200-1 24V 25V 件号: 1-81200-365-2 0-33000-6000
 FG-0002 型号: EX200-2 6BD1/住友200 件号: 24V 30A 1-81200-440 -2/0-33000-6552 9218005	 FG-0002 型号: EX200-5 6BG1 件号: 24V 40A 1-81200-471 -0/0-35000-3872	 FG-0002 型号: ZAX230/240 3PK 件号: 4HK1	 FG-0002 型号: ZAX330 6HK1
 FG-0002 EX55 4LE1	 FG-0002 型号: ZAX200-6 6BG1 件号: 24V 50A	 FG-0002 DH220-5	 FG-0002 型号: E320B/E320C 件号: 34368-01100 A4T6686 24V 35A
 FG-0002 型号: 3306 CAT OLD TYPE 件号: 6N9294 24V 45A	 FG-0002 SK200-6 SK230-6 6D34 24V 35V ME08887 A3TN5399	 FG-0002 R210-5 MITSUBISHI D6BR	 FG-0002 4M40
 FG-0002 VOLVO 210	 FG-0002 VOLVO 旧款	 FG-0002 J08 J05	 FG-0002 型号: R60-7 件号: 119626-77210



风叶系列 FAN BLADE SERIES



风叶系列 FAN BLADE SERIES

风叶系列

风叶系列

 FG-0002 4TNV94-98 *462-Ø28-52-4T8	 FG-0002 PC130 *550-Ø51-89-6T10	 FG-0002 6D125 *850-Ø50-89-6T6	 FG-0002 6D14/15 *600-Ø38-66-4T8 ME039960
 FG-0002 6D16 *650-Ø108-128-6T8	 FG-0002 4D31 *510-Ø38-65-8T7	 FG-0002 4M40 *440-Ø17-50-4T8	 FG-0002 6D22 SK300 *700-Ø108-128-6T8
 FG-0002 6D31 *600-Ø34-72-4T7	 FG-0002 H06CT *660-Ø50-75-4T8	 FG-0002 H07CT *680-Ø50-75-4T6	 FG-0002 J05E *650-Ø100-132-6T7
 FG-0002 DH220-5 *620-Ø32-60-4T9	 FG-0002 DH300 *680-Ø42-62-6T8	 FG-0002 VOLVO240 沃尔沃 *750-Ø76-134-6T11 11117033	 FG-0002 VOLVO360 沃尔沃 *710-Ø76-134-6T9 14508257
 FG-0002 VOLVO210 沃尔沃*680-Ø82-97-4T9 沃尔沃*660-Ø82-97-4T9 14516603	 FG-0002 6SD1 *700-Ø145-170-6T6 HITACHI	 FG-0002 4BD1 *520-Ø36-60-4T6 1-13360-029-0	 FG-0002 4JB1 *450-Ø32-60-4T7 21060-90069

 FG-0002 6BD1 *600-Ø108-128-4T8 1-13360-140-0	 FG-0002 6BG1 *620-Ø36-60-4T6 EX200-5 1-13660-289-0	 FG-0002 4BG1 *550-Ø32-60-4T8 8-97161-600-0	 FG-0002 S4F *440-Ø30-50-4T8
 FG-0002 4HK1 *620-Ø36-76-6T5	 FG-0002 6HK1 *850-Ø108-128-4T6	 FG-0002 4BG1 *550-Ø36-60-4T7	 FG-0002 S6K 六片 *600-Ø38-66-4T6 CAT320B
 FG-0002 320D *740-Ø127-152-6T10 2459343	 FG-0002 KOMATSU 4D102 *540-Ø51-89-6T10 600-625-7550	 FG-0002 6D102 *620-Ø51-89-6T9 600-625-7620	 FG-0002 6D108 *850-Ø50-89-6T6 6D114 *870-Ø50-89-6T6 600-635-7870
 FG-0002 4D95 *520-Ø50-89-6T7	 FG-0002 6D95 *620-Ø51-89-6T7 6D105 *580-Ø51-89-6T7 600-625-6620	 FG-0002 PC200-1 *700-Ø51-89-6T7 600-625-0700	 FG-0002 4BT3.9 *550-Ø25-60-8T10
 FG-0002 *550-Ø42-64-4T10	 FG-0002 洋马4TNV88 *410-Ø28-52-4T8	 FG-0002 4D84 *440-Ø82-97-4T7 *404-Ø82-97-4T7 YANMAM	 FG-0002 PC30反向 *360-Ø24-40-4T6



排气管 EXHAUST PIPE

FG-0002



V2403 排气管 Exhaust Pipe

FG-0002



V3300 排气管 Exhaust Pipe

FG-0002



V3800 排气管 Exhaust Pipe

FG-0002



4TNV84 排气管 Exhaust Pipe

FG-0002



S6D107 排气管 Exhaust Pipe

FG-0002



叉车V2403 排气管 Exhaust Pipe

FG-0002



PC100-3 排气管 Exhaust Pipe

FG-0002



6D95排气管 Exhaust Pipe



排气管 EXHAUST PIPE

FG-0002



PC200-3 6D105 排气管 Exhaust Pipe

FG-0002



PC200-3排气管 Exhaust Pipe

FG-0002



E200B 排气管 Exhaust Pipe

FG-0002



E320 排气管 Exhaust Pipe

FG-0002



6D31-6D34 排气管 Exhaust Pipe

FG-0002



6D31旧款排气管 Exhaust Pipe

FG-0002



6D14排气管 Exhaust Pipe

FG-0002



6BD1 排气管 Exhaust Pipe

排气管系列

排气管系列



专题KUMATSU S6D107 SERIES



专题KUMATSU S6D107 SERIES

FG-0002



S6D107
缸体

FG-0002



S6D107
缸盖

FG-0002



S6D107 大修包

FG-0002



S6D107 增压器

FG-0002



S6D107 柴油泵齿

FG-0002



S6D107
活塞

FG-0002



S6D107
活塞环

FG-0002



S6D107 柴油泵执行器

FG-0002



S6D107 柴油滤芯座连接块接头

FG-0002



S6D107 发动机电脑版绝缘胶

FG-0002



S6D107
大瓦

FG-0002



S6D107
小瓦

FG-0002



S6D107 发动机线束

FG-0002



S6D107 风扇连接块

FG-0002



S6D107 缸套

FG-0002



S6D107
活塞环

FG-0002



S6D107
气门

FG-0002



S6D107 高压共轨

FG-0002



S6D107 隔音垫

FG-0002



S6D107 共轨传感器

FG-0002



S6D107
气门过桥

FG-0002



S6D107
气门摇臂

FG-0002



S6D107 共轨压力阀

FG-0002



S6D107 活塞销

FG-0002



S6D107 机油尺及套管

专题KUMATSU S6D107系列

专题KUMATSU S6D107系列



专题KUMATSU S6D107 SERIES



专题KUMATSU S6D107 SERIES

FG-0002



S6D107 机油传感器

FG-0002



S6D107 机油滤芯座

FG-0002



S6D107 机油散热器盖

FG-0002



S6D107 喷油嘴连杆件

FG-0002



S6D107 喷油嘴线束

FG-0002



S6D107 曲轴

FG-0002



S6D107 机油散热器芯片

FG-0002



S6D107 机油泄压阀组

FG-0002



S6D107 节温器

FG-0002



S6D107 曲轴皮带减震盘

FG-0002



S6D107 曲轴皮带轮

FG-0002



S6D107 曲轴皮带信号轮

FG-0002



S6D107 康明斯QSB柴油泵4988593

FG-0002



S6D107 康明斯QSB柴油泵4988593

FG-0002



S6D107 空滤进气压力传感器

FG-0002



S6D107 曲轴箱呼吸器

FG-0002



S6D107 软管

FG-0002



S6D107 时规盖

FG-0002



S6D107 空气进气弯管

FG-0002

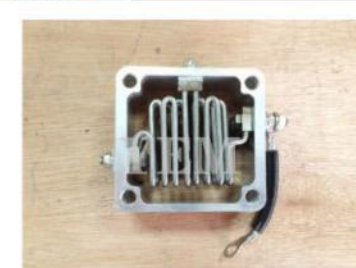

S6D107 空气预热器

FG-0002



S6D107 排气支管

FG-0002



S6D107 手油泵 (柴油滤座)

FG-0002



S6D107 水温传感器

FG-0002



S6D107 推杆

FG-0002



S6D107 喷油器接头

FG-0002



S6D107 喷油器直通体

FG-0002



S6D107 喷油器总成

FG-0002



S6D107 油底壳传感器

FG-0002



S6D107 增压器进油管

FG-0002



S6D107 转速传感器

专题KUMATSU S6D107系列

专题KUMATSU S6D107系列



增压器进(回)油管、机油管 DELIVERY LING

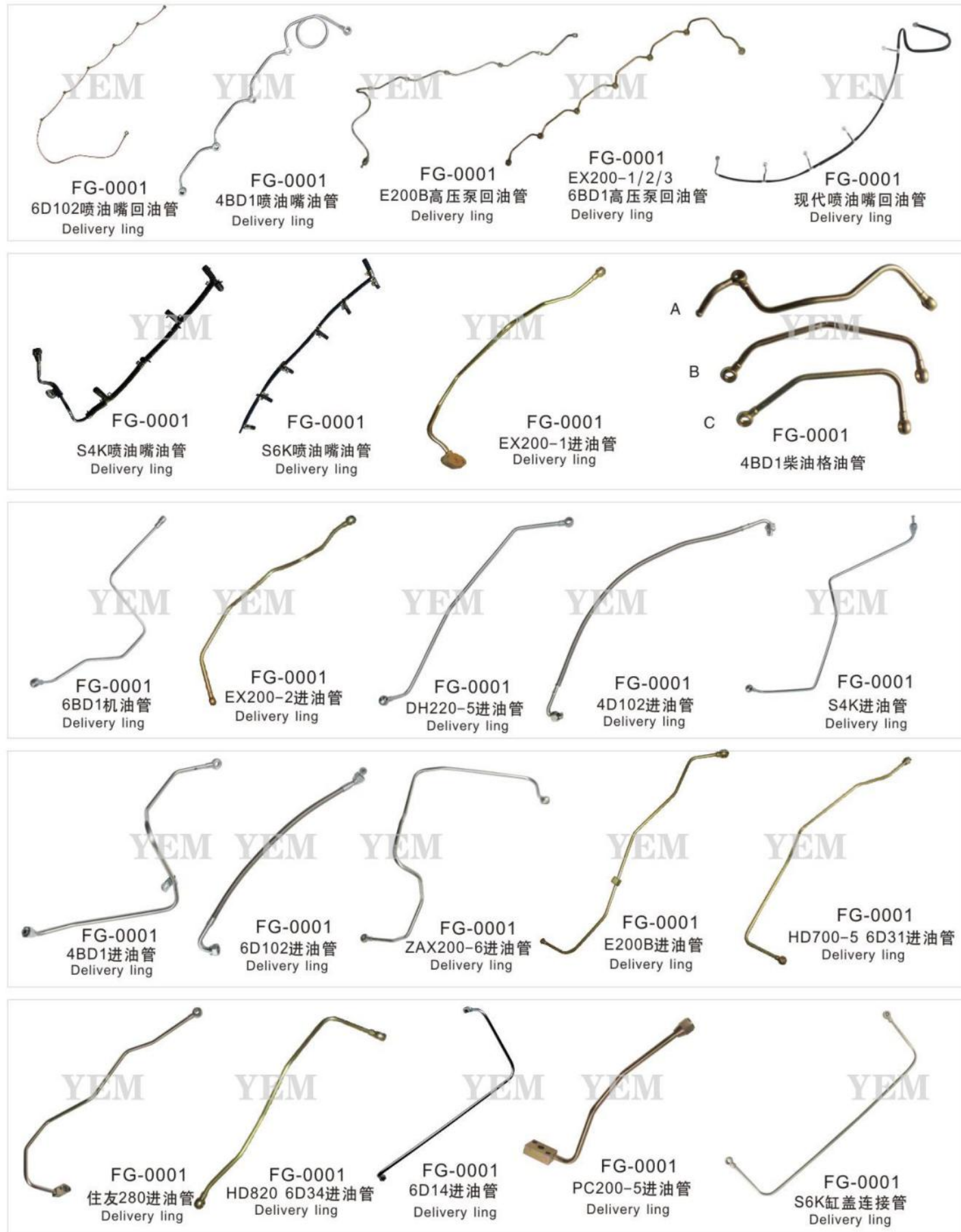

进油管机油管系列



增压器进(回)油管、机油管 DELIVERY LING

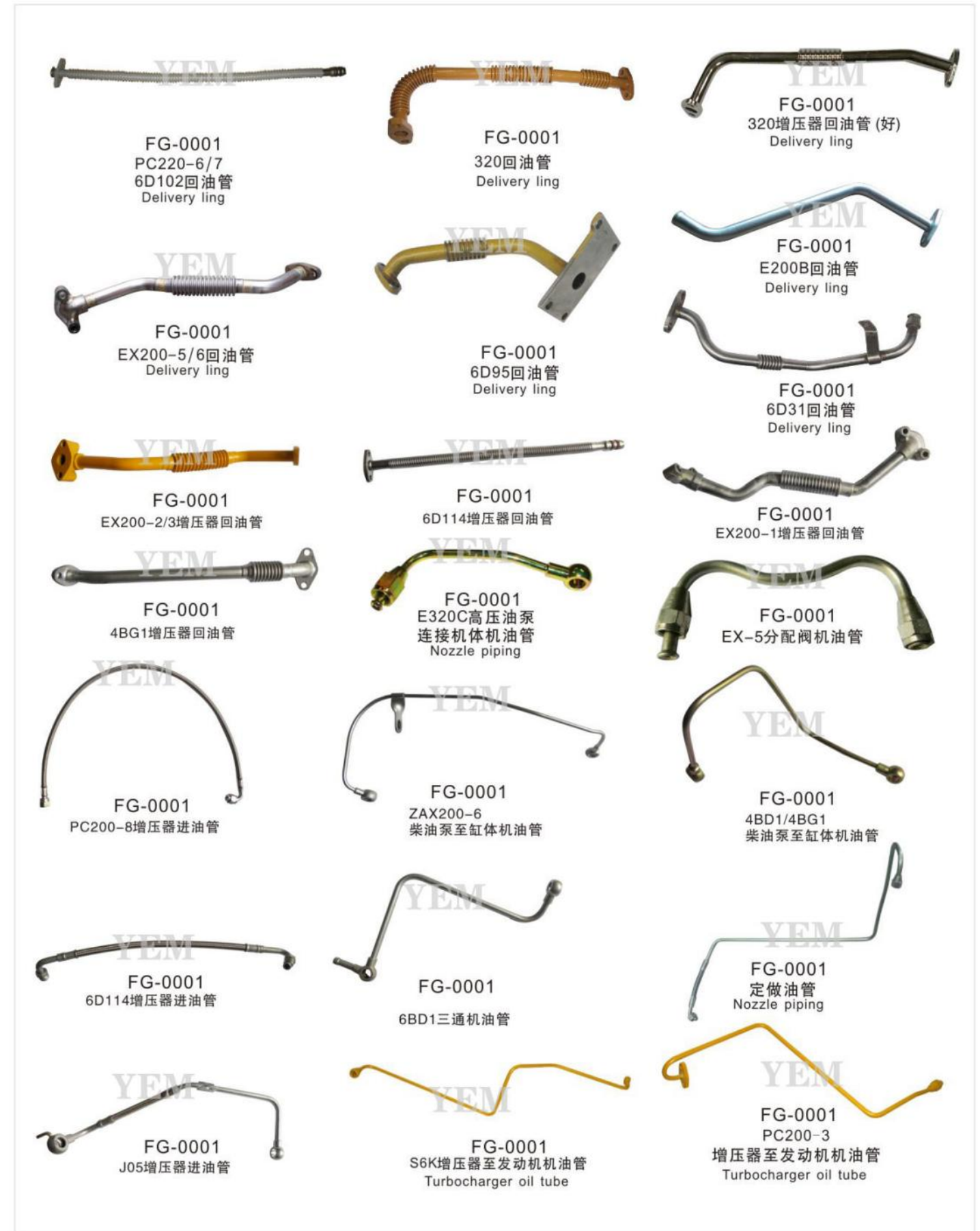

进油管机油管系列



高压油管 NOZZLE PIPING



PC200-6
6D95



6D125



6SD1

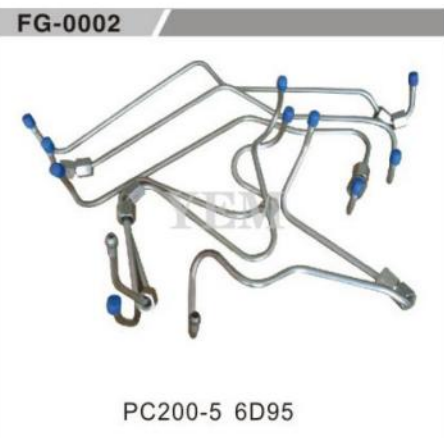

PC200-5 6D95

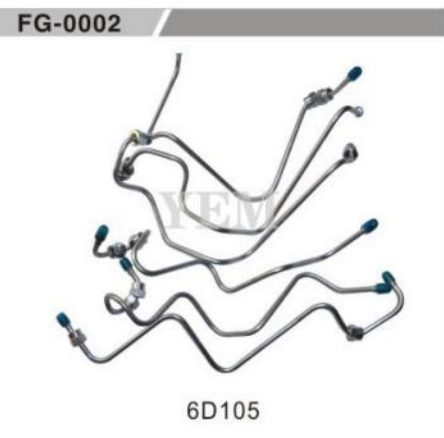

6D105

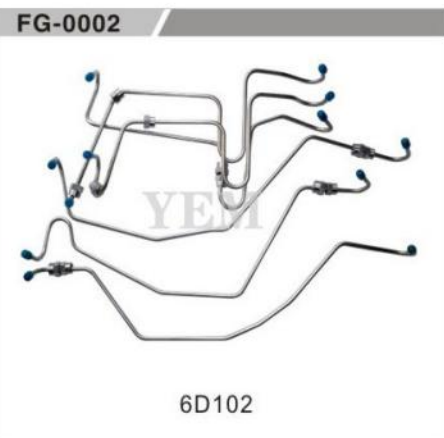

6D102



6D31

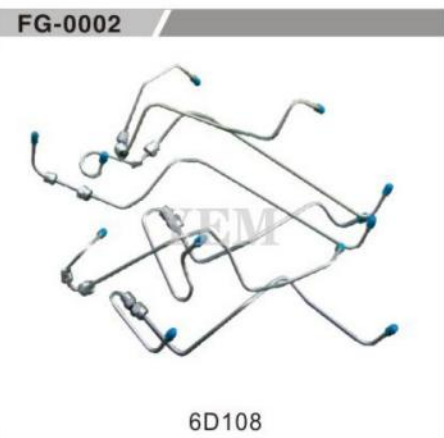

6D108

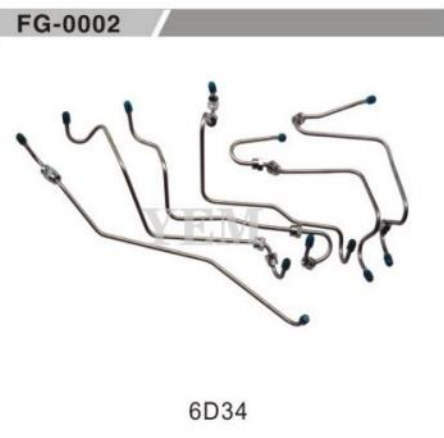

6D34

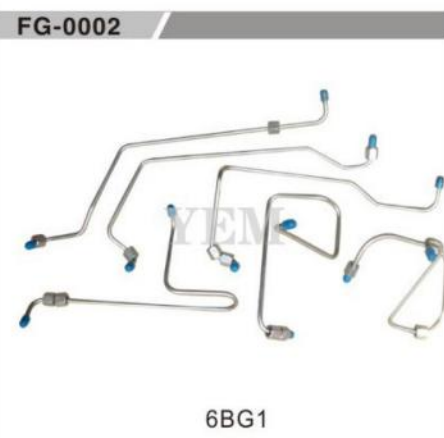

6BG1

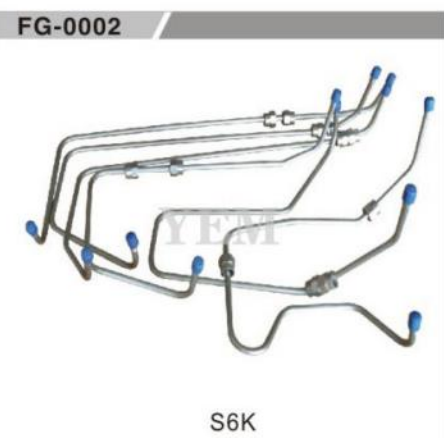

S6K

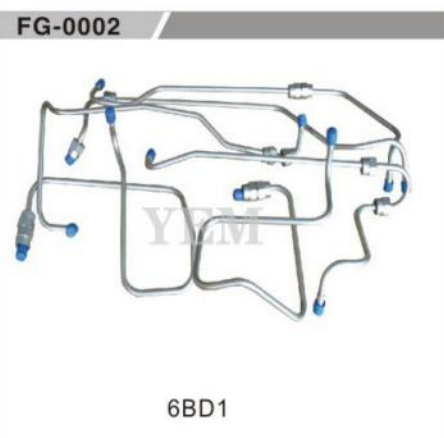

6BD1



高压油管 NOZZLE PIPING

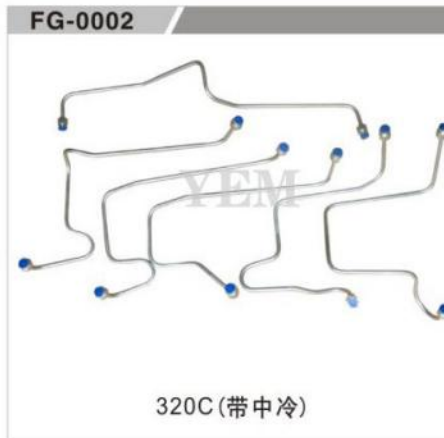

320C(带中冷)



4BD1



DH220-5

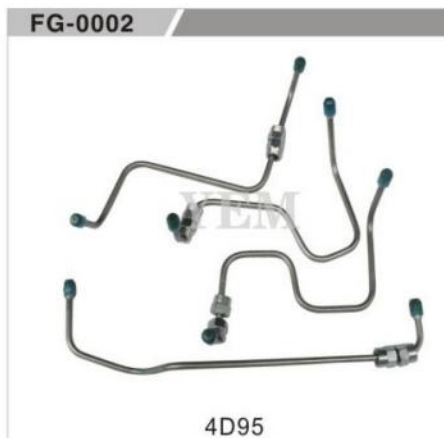

4D95



S4K



6BT5.9



VOLVO

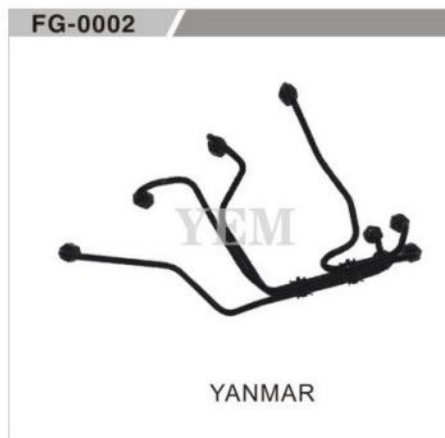

YANMAR



PC360-7



320D



4HK1



YEM

高压油管系列

高压油管系列



自动油门马达及配件
MOTOR ASS'Y AND PARTS



FG-0002



PC120-5 PC200-5
PC220-5 S6D95
7824-30-1600

FG-0002



PC120-6 PC200-6 PC220-6
6D102 PC300-6
6D102
7834-40-2000/3000/2002/2003

FG-0002



PC200-7 PC220-7 6D102
7834-41-2002
7834-41-2001

FG-0002



E320C (7线)
247-5212
227-7672

FG-0002



E320双线

FG-0002



E320单线

FG-0002



小松 PC60-7

FG-0002



EX200-1/2
4257163
4188762

FG-0002



EX200-5 EX200-6
ZAX200/ZAX210/220/
230/240/330 6BG1
ZAX210-330
4614911/4360509

FG-0002



HYUNDAI (LONG LINE) 现代长线
R225-5/7 21EN-32220

FG-0002



HYUNDAI (SHORT LINE)
现代短线 R220-5

FG-0002



三一重工 (SANY)

FG-0002



SK200-3/5
2406U197F4

FG-0002



SK200-6 SK230-6E
KP56RM2G-011
YT13E01085P1
20S00002F1
20S00002F3

FG-0002



DH220-5 (圆型)
2523-9014

FG-0002



SANY 三一重工油门马达
AC2/2000 012941

FG-0002



HD820 709-4500006

FG-0002



SH 油门电机 9线

FG-0002



DH220-5 (方型)
523-00006

FG-0002



CAT307

FG-0002



E320B (6线)
247-5231
1190-0633

FG-0002



住友200A3油门马达

FG-0002



SH 油门电机 12线

FG-0002



PC228UU 油门电机

电
器
件
系
列

电
器
件
系
列



自动油门马达及配件
MOTOR ASS'Y AND PARTS

水温感应器 WATER TEMP SENSOR

 EX200-5/ZAX200-6 ZAX210/220/230/240/330 6BG1/4614912 油门马达定位器 FITTING SENSOR	 EX-2油门传感器 Sensor	 PC200-5 7860-93-4131 油门马达定位器 Fitting Sensor	 PC200-6 7861-93-4131 油门马达定位器 Fitting Sensor	 PC200-7 7861-93-4130 油门马达定位器 Fitting Sensor	
 E320B/C 247-5230 油门马达定位器 Fitting Sensor	 SK230-6 油门马达定位器 Fitting Sensor	 R现代定位器	 油门旋钮 Dial, fuel PC200-5/6 7825-30-1301	 油门旋钮 Dial, fuel HITACHI EX 4341545	
 油门旋钮 Dial, fuel SK200-6	 大字DH220-5 油门旋钮 DIAL FUEL	 卡特油门旋钮(方插) E320B/E320C DIAL FUEL	 卡特油门旋钮(圆插) E320/E320A/E312 DIAL, fuel	 PC200-7油门电位计	
 油门马达橡胶齿 RUBBER GEAR EX120 EX200-5/6 EX220	 油门马达齿 GEAR PC200-5/6	 油门小电机 accelerator CAT320B/C 24V RS-755S	 油门小电机 accelerator 现代 HYUNDAI KATO/E320	 油门马达模块 Motor Drive Module E320B 6 LINES	 油门马达模块 Motor Drive Module E320C 7 LINES
 SK油门推销 SK-3油门马达摇臂和拉杆 SWING URM	 卡特CAT CLUTCH	 油门手柄 CLUTCH PC60/PC120 203-42-61370	 油门手柄 CLUTCH CAT ERPILLAR KATO	 SK油门推杆 SPRING ASSY	 油门推杆 SPRING ASSY PC120-5
 油门推杆 SPRING ASSY PC100-5	 油门推杆 SPRING ASSY PC100-5/6 6D95 PC60 4D95	 油门推杆 SPRING ASSY PC60	 油门推杆 SPRING ASSY PC300 6D125 PC200-6 6D102	 油门推杆 LEVER PC120 20Y-43-12143	 油门推杆 LEVER PC200-5 20Y-43-12141

 小松水温感应器 PC 08620-00000 WATER TEMP SENSOR	 PC200-5水温感应器 PC 7861-92-3320 WATER TEMP SENSOR	 PC200-7水温感应器 PC200-7 7861-93-3320 WATER TEMP SENSOR	 ZAX电喷水温报警器 ZAX电喷 WATER TEMP SENSOR
 ZAX200水温报警器 ZAX200 WATER TEMP SENSOR	 日立200-5水温报警器 EX200-5 8-97125601-1 WATER TEMP SENSOR	 日立水温感应器 EX200-2/5 4257129 WATER TEMP SENSOR	 6HK1水温传感器 6HK1 WATER TEMP SENSOR
 SK-8水温传感器 SK200-3 HD700-7 6D31/6D34 ME049 265 WATER TEMP SENSOR	 SK200-3水温感应器 SK200-3 SWZ489U268F1 WATER TEMP SENSOR	 神钢水温感应器 SK200-6/6E WATER TEMP SENSOR	 水温报警器(双插) SK200-6 HD700-7 6D31/6D34 ME049 265 WATER TEMP SENSOR
 水温报警器(单插) SK200-6 HD700-7 6D31/6D34 ME049 265 WATER TEMP SENSOR	 住友水温感应器 SH200-3 WATER TEMP SENSOR	 通用水温感应器(单插) ISUZU TOYOTA 4BD1 WATER TEMP SENSOR	 通用水温感应器(双插) MITSUBISHI ISUZU WATER TEMP SENSOR
 水温感应器 WATER TEMP SENSOR VOLVO	 水温感应器 WATER TEMP SENSOR	 大字水温传感器 DH220-5 WATER TEMP SENSOR	 洋机油感感塞 YANMAR OIL PRESSURE SWITCH

电
器
件
系
列

电
器
件
系
列























转速传感器 REVOLUTION SENSOR

电磁阀线圈 SOLENOID COIL



电
器
件
系
列

电
器
件
系
列

<p>FG-0002</p>  <p>卡特330C转速传感器 E330C REVOLUTION SENSOR</p>	<p>FG-0002</p>  <p>卡特330B转速传感器 E330B/E3306 REVOLUTION SENSOR</p>	<p>FG-0002</p>  <p>卡特转速传感器 (圆插) E320B E200B 196-7973 125-2966 REVOLUTION SENSOR</p>	<p>FG-0002</p>  <p>卡特转速传感器 (方插) E320C 51-7579 REVOLUTION SENSOR</p>
<p>FG-0002</p>  <p>SK 200-6转速传感器 SK200-6 SK200-6E 6S34T MC849577 REVOLUTION SENSOR</p>	<p>FG-0002</p>  <p>SK200-3/5转速传感器 SK200-3 SK200-5 6D31T MC845235 REVOLUTION SENSOR</p>	<p>FG-0002</p>  <p>SK200-8转速传感器 SK200-8 REVOLUTION SENSOR</p>	<p>FG-0002</p>  <p>小松200-6转速传感器 PC200-3/5/6 PC220-6 6D102 7861-92-2310 REVOLUTION SENSOR</p>
<p>FG-0002</p>  <p>小松200-7转速传感器 PC200/220-7 7861-93-2310 REVOLUTION SENSOR</p>	<p>FG-0002</p>  <p>日立转速传感器 EX200-1/2/3/5 EX120 4265372 REVOLUTION SENSOR</p>	<p>FG-0002</p>  <p>大宇转速传感器 DH220-5/7 2547-1015 REVOLUTION SENSOR</p>	<p>FG-0002</p>  <p>现代转速传感器 DH220-5/7 21E3-0042 REVOLUTION SENSOR</p>
<p>FG-0002</p>  <p>ISUZU 6BD1 转速传感器 REVOLUTION SENSOR</p>	<p>FG-0002</p>  <p>R225-7 REVOLUTION SENSOR</p>	<p>FG-0002</p>  <p>转速传感器 REVOLUTION SENSOR</p>	<p>FG-0002</p>  <p>住友转速传感器 SH REVOLUTION SENSOR</p>
<p>FG-0002</p>  <p>卡特320B水温感应器 E320B 51-7578 34390-00800 2979315 WATER TEMP SENSOR</p>	<p>FG-0002</p>  <p>卡特330B水温感应器 E330B WATER TEMP SENSOR 卡特320C油温传感器 E320C HYD DIL TEMP SENSOR</p>	<p>FG-0002</p>  <p>卡特320C水温传感器 E320C 135-2336 34390-02200 WATER TEMP SENSOR</p>	<p>FG-0002</p>  <p>PC200-6水温感应器 E320C PC200-6 PC220-6 7861-92-3380 WATER TEMP SENSOR</p>

<p>FG-0002</p>  <p>现代电磁阀线圈 R215-7 SOLENOID COIL</p>	<p>FG-0002</p>  <p>现代电磁阀线圈 R60-5/7 SOLENOID COIL</p>	<p>FG-0002</p>  <p>现代电磁阀线圈 R225-7 SOLENOID COIL</p>	<p>FG-0002</p>  <p>现代电磁阀线圈 R55 SOLENOID COIL</p>
<p>FG-0002</p>  <p>现代电磁阀线圈(方) R210/220-5 R200 SOLENOID COIL</p>	<p>FG-0002</p>  <p>现代电磁阀线圈(圆) R210/220-5(圆) SOLENOID COIL</p>	<p>FG-0002</p>  <p>小松120电磁阀线圈 PC125-6/PC60-6(新) PC60-7 SOLENOID COIL</p>	<p>FG-0002</p>  <p>小松旋转电磁阀线圈 PC200-6/6D102 SOLENOID COIL</p>
<p>FG-0002</p>  <p>小松60电磁阀线圈 PC60-5/PC60-6 (老) PC120-5 SOLENOID COIL</p>	<p>FG-0002</p>  <p>小松旋钮电磁阀线圈 PC200-5 PC200-6/6D95 SOLENOID COIL</p>	<p>FG-0002</p>  <p>小松旋转电磁阀线圈 PC200-7/PC220-7 PC200-8 SOLENOID COIL</p>	<p>FG-0002</p>  <p>大宇电磁阀线圈(24V) DH220-5 SOLENOID COIL</p>
<p>FG-0002</p>  <p>大宇电磁阀线圈(12V) DH60-7 DH80-7 SOLENOID COIL</p>	<p>FG-0002</p>  <p>DH60-5/7 电磁阀线圈 12V SOLENOID COIL</p>	<p>FG-0002</p>  <p>DH60-5/7 电磁阀线圈 12V SOLENOID COIL</p>	<p>FG-0002</p>  <p>DH55 电磁阀线圈 SOLENOID COIL</p>
<p>FG-0002</p>  <p>DH55 电磁阀线圈 SOLENOID COIL</p>	<p>FG-0002</p>  <p>VOLVO210B 电磁阀线圈 SOLENOID COIL</p>	<p>FG-0002</p>  <p>三一/中联泵车 电磁阀线圈 SOLENOID COIL</p>	<p>FG-0002</p>  <p>三一泵车 电磁阀线圈 SOLENOID COIL</p>
<p>FG-0002</p>  <p>三一/中联泵车 电磁阀线圈 SOLENOID COIL</p>	<p>FG-0002</p>  <p>玉柴小挖 YC60-7 R60-7 0D13105130 电磁阀线圈 SOLENOID COIL</p>	<p>FG-0002</p>  <p>沃德60-5/7 12V 电磁阀线圈 SOLENOID COIL</p>	



电磁阀 SOLENOID VALVE

电磁阀 SOLENOID VALVE



电
器
件
系
列

电
器
件
系
列

<p>FG-0002</p> <p>PC200-6液泵电磁阀(银白) PC200/220-6/6D102 702-21-07010 SOLENOID VALVE</p>	<p>FG-0002</p> <p>PC200-6液泵电磁阀 PC200/220-6 6D102 702-21-07010 SOLENOID VALVE</p>	<p>FG-0002</p> <p>PC200-7液泵电磁阀 PC200/220-7 PC200-8 702-21-57400/57500/55901 SOLENOID VALVE</p>	<p>FG-0002</p> <p>PC200-5液泵电磁阀 PC200-3/5 PC200-6/6D95 708-2H-25240 708-23-18272 SOLENOID VALVE</p>	<p>FG-0002</p> <p>长特320液泵电磁阀 E320 41-5674 SOLENOID VALVE</p>
<p>FG-0002</p> <p>卡特200B液泵电磁阀(副) E200B 086-1879 SOLENOID VALVE</p>	<p>FG-0002</p> <p>K3V112液泵电磁阀(黑插) SK200-6/6E DH220-5 MC609-7421120 KDRDE5K-31/30C50-102 SOLENOID VALVE</p>	<p>FG-0002</p> <p>K3V112液泵电磁阀(圆插) SK200-1/3 R210-5 HD700-7/HD800-7 KDRDE3K-10/40 SOLENOID VALVE</p>	<p>FG-0002</p> <p>K3V112液泵电磁阀(白插) SK200-5/6 DH220-5 R210-5 SOLENOID VALVE</p>	<p>FG-0002</p> <p>神钢液泵电磁阀 SK200-6E SK230-6E SKX5P-17-208 KDRDE5K-20/40C07-203A SOLENOID VALVE</p>
<p>FG-0002</p> <p>神钢液泵电磁阀 SK200-8 YN35V0004F1 SKX5P-17-212A KDRDE5K-20/30C12A-111 SOLENOID VALVE</p>	<p>FG-0002</p> <p>PC200-5/6D95旋转电磁阀 PC200-5/6D95 20Y-60-11712/11713 SOLENOID VALVE</p>	<p>FG-0002</p> <p>PC200-6/6D95旋转电磁阀 PC200-6/6D95 20Y-60-22121/22123 SOLENOID VALVE</p>	<p>FG-0002</p> <p>PC200-6/6D102旋转电磁阀 PC200-6/6D102 206-60-51130/51131/51132 SOLENOID VALVE</p>	<p>FG-0002</p> <p>PC200-7旋转电磁阀 PC200/220-7/PC200-8 20Y-60-32120/32121 SOLENOID VALVE</p>
<p>FG-0002</p> <p>PC200-6/6D102旋转电磁阀(银白) PC200-6/6D102 206-60-51130/51131/51132 SOLENOID VALVE</p>	<p>FG-0002</p> <p>PC200-7旋转电磁阀(银白) PC200/220-7/PC200-8 20Y-60-32120/32121 SOLENOID VALVE</p>	<p>FG-0002</p> <p>小松60-5旋转电磁阀 PC60-5/PC120-5/PC60-6(老) 203-60-56180/SD1169-24-11 SOLENOID VALVE</p>	<p>FG-0002</p> <p>小松120-6旋转电磁阀 PC120-6/PC60-7/PC60-6(新) 203-60-62171/62161 203-60-56560/SD1244-C-10 SOLENOID VALVE</p>	<p>FG-0002</p> <p>卡特320旋转电磁阀 E320 SOLENOID VALVE</p>
<p>FG-0002</p> <p>E200B主泵电磁阀带座(主) SOLENOID VALVE (MAIN)</p>	<p>FG-0002</p> <p>卡特320B主泵电磁阀 E320B 139-3990/51-8368 SOLENOID VALVE</p>	<p>FG-0002</p> <p>主泵电磁阀带座 SOLENOID VALVE(MAIN) 神钢住友</p>	<p>FG-0002</p> <p>小松转载机电磁阀 PC 561-15-47210 SOLENOID VALVE</p>	<p>FG-0002</p> <p>电源电磁阀 SOLENOID VALVE E320C E312C</p>

<p>FG-0002</p> <p>日立高速电磁阀 EX120 EX200-2/3/5 9147260/9120191 SOLENOID VALVE</p>	<p>FG-0002</p> <p>日立压差传感器(老款) EX200-1/2/3 EX220-2 9101532/9102068 D.P.SENSOR</p>	<p>FG-0002</p> <p>日立角度传感器 EX200-2/3 EX120 4444902 ANGULAR SENSOR</p>	<p>FG-0002</p> <p>EX200-2/3电磁阀 SOLENOID VALVE</p>
<p>FG-0002</p> <p>ZAX200电磁阀 SOLENOID VALVE</p>	<p>FG-0002</p> <p>日立主泵提升器电磁阀 EX200-5 9745876 MAIN PUMP SOLENOID</p>	<p>FG-0002</p> <p>雷沃电磁阀 SOLENOID VALVE</p>	<p>FG-0002</p> <p>卡特旋转电磁阀(红点) E320B/E320C 121-1491 SOLENOID VALVE</p>
<p>FG-0002</p> <p>卡特旋转电磁阀(黄点) E320B/E320C 111-9916 SOLENOID VALVE</p>	<p>FG-0002</p> <p>卡特旋转电磁阀(蓝点) E320B/E320C 121-1490 SOLENOID VALVE</p>	<p>FG-0002</p> <p>SK200-6E行走直进电磁阀 SK200-6E SK230-6E YN35V00005F1 KDRDE5K-31/30C50-107 SOLENOID VALVE</p>	<p>FG-0002</p> <p>SK200-6E液泵比例阀 SK200-6E SK230-6E YN35V00004F1 KDRDE5K-31/30C50-102 SOLENOID VALVE</p>
<p>FG-0002</p> <p>SK200-6E旋转刹车电磁阀 SK200-6E SK230-6E YN35V00006F1 KWE5K-31/G24YA50 SOLENOID VALVE</p>	<p>FG-0002</p> <p>SK200-6电磁阀 SK200-6 KWE5K-31/G24DB40 SOLENOID VALVE</p>	<p>FG-0002</p> <p>SK200-6液泵比例阀 SK200-6 YN35V00018F2 KDRDE5K-31/30C40-111 SOLENOID VALVE</p>	<p>FG-0002</p> <p>SK200-6安全锁定电磁阀 SK200-3 SK200-6 YN35V00020F1 KWE5K-31/G24DA40 SOLENOID VALVE</p>
<p>FG-0002</p> <p>SK200-8液泵电磁阀 SK200/260/330/350-8 YN35V00052F1 KDRDE5K-31/30C50-123 SOLENOID VALVE</p>	<p>FG-0002</p> <p>SK200-8安全锁定电磁阀 SK200/330/350-8 YN35V00050F1 KWE5K-31/G24DB50 SOLENOID VALVE</p>	<p>FG-0002</p> <p>SK200-6旋转刹车电磁阀 SK200-6 YN35V00021F1 KWE5K-30/G24YA40 SOLENOID VALVE</p>	<p>FG-0002</p> <p>神钢吊机电磁阀 SK SOLENOID VALVE</p>



节温器 THERMOSTAT SERIES

节温器 THERMOSTAT SERIES

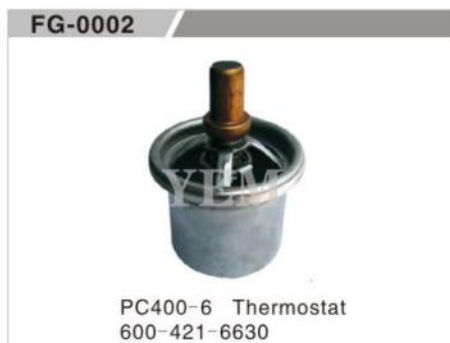

通用件系列

通用件系列



油箱传感器 FUEL TANK SENSOR





熄火开关 FLAMEOUT SOLENOID



电
器
件
系
列

电
器
件
系
列

<p>FG-0002</p>  <p>油箱传感器 Fuel Tank Sensor PC200-6 7861-92-6810/5810</p>	<p>FG-0002</p>  <p>油箱传感器 Fuel Tank Sensor PC200-5 7861-92-4800</p>
<p>FG-0002</p>  <p>油箱传感器 Fuel Tank Sensor EX200-1/2 4257128</p>	<p>FG-0002</p>  <p>油箱传感器 Fuel Tank Sensor CAT320B/C 238-2227/163-6700</p>
<p>FG-0002</p>  <p>油箱传感器 Fuel Tank Sensor CAT320 105-9993X</p>	<p>FG-0002</p>  <p>油箱传感器 Fuel Tank Sensor CAT 320B</p>
<p>FG-0002</p>  <p>油箱传感器 Fuel Tank Sensor KATO 加藤</p>	<p>FG-0002</p>  <p>油箱传感器 Fuel Tank Sensor KOBELCO 神钢</p>
<p>FG-0002</p>  <p>油箱传感器 FUEL TANK SENSOR DH220-5 DOOSAN</p>	<p>FG-0002</p>  <p>油箱传感器 Fuel Tank Sensor SH A3</p>
<p>FG-0002</p>  <p>油箱传感器短 Fuel Tank Sensor HYUNDAI 现代</p>	<p>FG-0002</p>  <p>油箱传感器长 Fuel Tank Sensor HYUNDAI 现代</p>

<p>FG-0002</p>  <p>24V 3990771 SA-4931-24</p>	<p>FG-0002</p>  <p>12V 3921978 24V 3921980</p>	<p>FG-0002</p>  <p>24V B4000-1115030</p>	<p>FG-0002</p>  <p>24V 1756ES-24E3ULB1S5 SA-4735-24 11033561</p>
<p>FG-0002</p>  <p>12V 3357411 24V 961000780034 3355427 2TB130805</p>	<p>FG-0002</p>  <p>24V 3939019 SA-4889-24</p>	<p>FG-0002</p>  <p>12V 3932545 SA-4639-12 24V 3932546 SA-4639-24</p>	<p>FG-0002</p>  <p>12V 1751ES-12A3UC12B1S</p>
<p>FG-0002</p>  <p>12V 119653-77950 119285-77950 1503ES-12S5SUC5S 24V 1503ES-24S5SUC5S</p>	<p>FG-0002</p>  <p>12V 119233-77932 119233-77931 1503ES-12S5SUC12S 24V 1503ES-24S5SUC12S</p>	<p>FG-0002</p>  <p>12V 25-38109-05Z 25-38109-05S SA-5019 SA-5157 SA-4668-S 1503ES-12A5SUC9SCC28 1503ES-12A5SUC9SCG28</p>	<p>FG-0002</p>  <p>12V 1503ES-12A5UC5S 17454-60010 SA-4569-T 24V 1503ES-24A5UC5S SA-4567-T</p>
<p>FG-0002</p>  <p>12V 2848A279 SA-4934-12 2848A271 24V SA-4934-24</p>	<p>FG-0002</p>  <p>12V 1751ES-12A6UC4B3S1 87801213 87616313 F2NN9D278BA F3NN9D278BA SA-4161-12 24V 1751ES-24A6UC4B3S1 SA-4161-24</p>	<p>FG-0002</p>  <p>E330/330B/330C 3306 155-4653</p>	<p>FG-0002</p>  <p>E325C 3116 CAT 155-4652</p>
<p>FG-0002</p>  <p>HD800/900 HD250/450 12V/24V</p>	<p>FG-0002</p>  <p>37B34-56010 24V</p>	<p>FG-0002</p>  <p>EX55 A036 3175 DC 12V ISUZU</p>	<p>FG-0002</p>  <p>大宇DH225-7 2523-9016</p>



熄火电磁阀 FLAMEOUT SOLENOID VALVE

FG-0002



1C010-60015

FG-0002



1C010-60017

FG-0002



1E152-60011

FG-0002



1G772-60012

FG-0002



1G772-60013

FG-0002



1G820-60022

FG-0002



1503ES-12A5UC4S

FG-0002



1503ES-12A5UC9SCC28

FG-0002



17208-60016

FG-0002



洋马电子燃油泵 FUEL PUMP
12V/24V YANMAR 4TNV94/98
129612-52100

FG-0002



洋马电子泵 长
FUEL PUMP

FG-0002



洋马电子燃油泵 带调节器
FUEL PUMP
YANMAR 久保田 12V

油缸总成 JACK CYLINDER



FG-0001
液压油缸零件



FG-0001
缸盖、活塞、螺母、前后缓冲



FG-0001
缸盖 Cylinder Head



FG-0001 缸筒



FG-0001 油缸总成



FG-0001 活塞杆



FG-0001
活塞 Jack piston

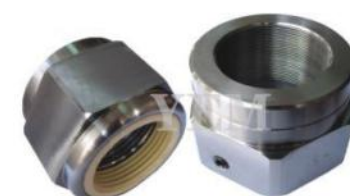

FG-0001
罗母 Jack Shaft Nut



FG-0001
杯士 Bushing



FG-0001
缓冲套

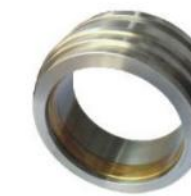

FG-0001
内缸盖 Collar



链轨总成 TRACK LINK ASSY



TRACK LINK ASSY 链轨总成 FG-0002

序号	代号	节距	零件号	螺孔直径	节数	重量	适用机型
No.	Ref. No.	Pitch	Code	Hole	Link	P/W	Model
1	135GA	135	20T-32-00140	12.5	38	130	PC40-7 PC45-1
2	135MA	135	201-32-00131,10G-32-00111	12.5	42	169	PC60-3/5 D20
3	140GA	140		12.5	42	140	YC85 XCG88
4	154GA	154	9068163, 9096170	14.3	37	178	EX60 EX60-2/3
5	154MC	154	201-32-00300	14.3	38	170	PC60-6/7 PC75UU
6	154MB	154	11G-A70-0013	14.3	41	268	D31P SD08
			202-32-00114		43	281	PC100-2
			202-32-00131,11G-A74-0012		46	300	PC100U-2 PC100(120)-3 D31PLL
7	156MG	156	6Y1711	14.7	36	198	D3C
8	171MA	171.1	24100J116939F1	16.4	41	295	SK100 SK100-3/5 SK110
			24100J12245F5		43	310	SK120-2/3 SK130
9	171MD	171.45	9070369	16.4	45	450	EX150-1
			9071452		47	470	EX100M EX150LC-1
10	171GC	171.45	C24500200,093-1919	16.4	39	310	MS110 E110 K904B
			9K9129		40	318	D4D
			099-5398,4I7479,9092929,9091948		41	326	E110B 311 EX100-1/2/3/5 S40 LS2600 K904N II YC135
			099-0648,4I7480,1469175,91091951		43	342	E120 E120B 312B 312 EX120-1 SH100 HD450 HD500 HD550 K904B-LC
			932015,9092932,9138747,KNA039		44	350	E140 SH120 LS2650 EX120-2/3/5 EX130H-5
			C34501201		45	358	MS110L EL120B
11	171ME	171.45	2S7579	16.4	40	425	D6B 951
12	171MB	171	T90.34.000	16.4	39	425	东方红 T100 T90
			1082-00060		50	545	R200 R210 SE210
			83E1-2502, 1082-00100		54	588	R200LC R210LC R210LC-2 SE210LC
13	175MG	175	202-32-00201	16.4	40	268	PC100-5/6 PC120-5
			203-32-00101		42	282	PC120LC-5 PC120-6 PC130-6
14	175GA	175.51		18.4	45	503	D5
			093-1927,9066724		48	537	MS180-8 E180 EX200-1 K907D-2 SK07-2 DH220
			KRA1260		49	548	S280 LS2800FJ2 SK07-N2 K907-II UH07-7
			093-1929,9073376,2272-7024		52	582	MS180LC EL180 EX200LC-1 K907LC-II SK07LC-N2 DH220LC DH180LC
15	175MJ	175.51		16.4	37	411	山推SD11
			12F-32-00045		43	478	D40 D41
			13F-32-00031		47	522	D50P-16 D53P-16
			13F-32-00062		49	544	D50P-17/18 D53P-17/18
16	175MH	175.51		18.4	48	528	HD700 HD770 PC150
					51	562	HD800 HD900
17	190MB	190	205-32-00031	18.4	43	505	PC200-1/2
			205-32-00051		45	528	PC180-3 PC200-3
			9135631,9092517, 9022210		46	540	EX200-2/3/5 ZX200 EX210-5 ZX210
			206-32-00031,9071451,9093029		47	551	PC220-3 EX100M-5 EX220-1/2/3/5
			205-32-00043,9098490,9135646,9200211		49	575	PC200LC-2/3 EX200LC-2/3/5 EX210LC-5 ZX200LC
18	190MA	190		20.5	38	446	山推SD13 TY120
			20Y-32-00013,1082-02210		45	528	PC200-5/6 R210-3 SE210-2/3 EC210-3
			206-32-00103,9066727,9093029		47	551	PC220-5/6 PC230-6 EX220-2/3/5 EX230-5
			20Y-32-00023,1082-02170		49	575	PC200(210)LC-3/5/6 SE210LC-2/3 EC210LC-3 DH220-3/5

底盘件系列

链轨总成 TRACK LINK ASSY



TRACK LINK ASSY 链轨总成 FG-0002

序号	代号	节距	零件号	螺孔直径	节数	重量	适用机型
No.	Ref. No.	Pitch	Code	Hole	Link	P/W	Model
			206-32-00113,9073253,9098259		51	598	PC220LC-3/5/6 PC230LC-6 EX220LC2/3/5
19	190MK	190	096-4301,9W9354,24100J11338F2	21	45	558	E200B 320 SK200-3/5
			087-8805,YN62D0007F1,KRA1254		46	570	E240 E240B/C SK200-6 SH200 HD820
			LQ62D00004F1,YN62D00013F1		48	595	SK220-5S SK230-6
			096-6203,9W9353,24100J12150F4		49	608	EL200B 320L SK200LC-3/5 SH200LC
20	203MG	202.8	3P1118	19.5	36	530	D6C D6D 955L
			3P11120		39	574	D6D-LS
			7S9569		41	604	D6C-LGP D6D-LGP
21	203MC	202.8	6Y0854 1151849	21	45	685	325 325B 320S
			24100J12450F3		46	700	SK220
22	203MD	203	144-32-00031	19.5	37	586	D60A-6/8 D65A-6/8 上海PD165
			141-32-00063		39	618	D60E-LK,D70-LK
			144-820-0025		44	697	D60P-6/8/11 D65P-6/8/11
23	203MJ	203.2		20.5	37	586	山推SD16 TY160
					42	666	山推SD16TL TSY160L
			14Y-32-00020		45	713	D60P-12 D65P-12
			207-32-00051,9140549,2272-6047,KSA0645		47	745	PC300-3 EX300-1/2/3 DH280 DH320 SH300 R290 R320
					48	761	HD1250 HD1430
			9071587,C8A0255		50	793	EX300LC-1/2/3 LS4300
			207-32-0009,2272-1074,83E5-2501,1082-02461		51	808	PC300LC-3 DH280LC DH320LC R290LC R320LC SE280LC-1/2/3 K912ALC
24	203ML	203.2	207-32-00100	22.5	47	745	PC300-5
25	203MB	203.2		20.5	37	556	上海PD120 PD140
					38	571	宣化T140 T165 鞍山T120 T150
			24100J10382F4		48	721	SK300-1/3
			24100J10382F		51	766	SK300LC-1/3
26	216MB	215.9	3P0629	19.5	38	706	D7G 山推SD22
27	216MA	216	154-32-00137	20.5	38	706	D80 D85 TY220
					40	743	宣化SD7
28	216MF	215.9	207-32-00030,9156481	22.3	45	735	PC300-6/7 PC360-7 EX300-5 /H-5/K-5
					47	768	SH330
			207-32-00031,9167840		48	784	PC300LC-6/7 PC350-6 R335-7 EX300LC-5
29	216MC	215.9	6Y2755,LC62D00001F1	22.8	45	865	330 SK330-6
30	216MD	216	81EH-26010	22.5	48	904	R350 R360 SE350 EC360
			9084353		49	923	EX400-1 PC400-1
			81EH-25010		51	961	R350LC,R360LC
			1082-01991		52	980	SE350LC,EC360LC
			9084356,2272-9402,81E7-0135		53	998	EX400LC-1 DH450LC S450LC R450LC
31	216ME	216	KSA1082	24.5	45	847	SH300-3
			KSA1165		48	904	SH300LC-3
			208-32-00101,9133225		49	923	PC400-3/-5,PC410-5 EX400-3/5 EX450-5
			208-32-00141		52	980	PC400LC-5
			208-32-00111,9129617		53	998	EX400LC-3/5 PC400LC-3
32	228MA	228.6	175-32-00016	24.5	41	1125	D150 D155 山推SD32 TY320
					43	1180	宣化SD8
33	228MB	228.6	208-32-00300	24.5	46	874	PC400-6 PC450-6
			208-32-00310		49	931	PC400LC-6 PC450LC-6
34	228MC	228.6	8S0398 2P9494	23.2	38	1043	D8K D8H
35	260MA	260.35		29.5	41	1855	山推SD42
36	260MB	260.35	195-32-00012	27.4	39	1765	D355 D9H D9G
					40	1810	上海PD410

底盘件系列



履带板 TRACK SHOE

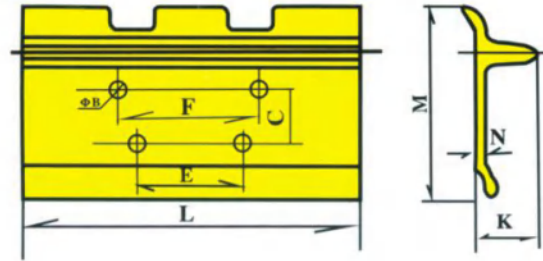
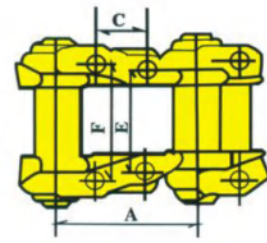

TRACK SHOE 履带板(DOZER) FG-0002

NO.	MODEL	A	B	C	E	F	K	L(mm)	M	N	MACHINE
1	228MA	228.6	24.5	76.2	169	219.8	97	560	268	17	D155
2	228MB	228.6	23.2	76.2	169.8	201.6	97	560	268	17	D8H D8K
3	216MB	216	19.5	76.2	146	184	86	560 / 610	250	14	D7G
4	216MA	216	20.5	76.2	146	184	86	560 / 610	250	14	D85
5	203MB	203	20.5	72	146	184	74	500 / 620	238	14	T140 TY120
6	203MJ	203	20.5	72	138.4	178.4	74	510/560/610	238	14	D65
7	203MD	203	19.5	72	138.4	178.4	74	510/560/610	238	14	D60 D65
		203	19.5	72	138.4	178.4	74	950			D60P(WET)
8	203MG	203	19.5	76.2	133.4	171.4	74	510/560/610	238	14	D6C D6D
	203MG	203	19.5	76.2	133.4	171.4	74	910			D6C D6D(WET)
9	203MK	203	20.5	68	137.3	185.3	90	510/560/610	243	15	D6H
10	175MJ	175.51	16.4	57	122.4	158.4	62	450	200	12	D50 D53
		175.51	16.4	57	122.4	158.4	62	860			D50 D53(WET)
11	175GA	175.51	18.5	58.7	125.4	144.5	62	450	200	12	D5 D6
12	171GC	171.45	16.5	60.3	107.9	107.9	62	450/ 510	200	12	D4D
13	154MB	154	14.3	57.1	82.4	112.4	56	400	167	10	D31E
		154	14.3	57.1	82.4	112.4	56	600 / 1050			D31P

TRACK SHOE 履带板(EXCAVATOR) FG-0002

NO.	MODEL	A	B	C	E	F	K	L(mm)	M	N	MACHINE
1	228MC	228.6	24.5	76.2	144	184	47	600	258	17	PC400-6
2	216ME	216	24.5	76.2	144	184	44	600/700/800	250	14	PC400-5
3	216MF	215.9	22.5	76.2	140.4	178.4	44	600/700/800	250	14	PC300-6 EX300-5 SH330
4	216MC	215.9	22.5	76.2	140	190	44	600/700/800	250	14	E330
5	216MD	216	22.5	76.2	146	184	44	600/700/800	250	14	PC400-1 EX400
6	203MC	202.8	20.5	72	129	179	41	600/700/800	236	13	E325
7	203ML	203.2	22.5	72	138.4	178.4	41	600/700/800	236	13	PC300-5
8	203MJ	203.2	20.5	72	138.4	178.4	41	600/700/800	236	13	PC300-3 EX300-3 DH280
9	190MA	190	20.5	62	124.4	160.4	35	600/700/800	219	10	PC200-5 EX220 R220
10	190MK	190	20.5	69	119.6	155.6	35	600/700/800	219	10	E320 SK200
11	190MB	190	18.5	62	124.4	160.4	35	600/700/800	219	10	PC200-3 EX200-2
12	175GA	175.51	18.5	58.7	125.4	144.5	35	500/600/700/800	198	9.5	EX200-1
13	175MG	175	16.5	57	86.4	102.4	35	500/600/700	198	9.5	PC100-5 PC120-5
14	175MH	175.51	18.5	57	122.4	158.4	35	500/600/700/800	198	9.5	HD800
15	171MB	171	16.5	58.7	125.4	144.5	26	500/600/700/800	190	8	R200
16	171GC	171.45	16.5	60.3	108	108	26	400/500/600	190	8	EX100 EX130 SK120
17	171GC	171.45	14.5	60.3	108	108	26	400/500/600	190	8	HD400 R912
18	154MC	154	14.5	57	73	89	26	400 / 450 / 500	165	7	PC60-6
19	154MB	154	14.5	57	82.4	112.4	26	400 / 450 / 500	165	7	PC100-1
20	154GA	154	14.5	55	90	90	26	400 / 450 / 500	165	7	EX60
21	135MA	135	12.5	43.2	72	99	20	400	154	6	PC60-3/5
22	135GA	135	12.5	46	63.8	93.8	20	400	154	6	PC40-7
23	135MD	135	12.5	46	80	104	20	400	154	6	EX40 EX45
24	135MF	135	12.5	46	55	85	20	400	154	6	PC40-5

引导轮 FRONT IDLER



FRONT IDLER 引导轮 FG-0002

序号	零件号	适用机型	重量
No.	Code	Model	Weight (kg)
1	6S9367, 6Y1318	D3B, D3C	57.0
2	1M8867	D4D	84.0
3	8S2560	D5, D6B, 955	132.6
4	8S2560G	D5, D6B, 955	190.0
5	7T4562, 5M5009	D6C, D6D	137.0
6	7T4562G	D6C, D6D	210.0
7	6T3216	D6H	155.0
8	7T4509, 1S8186	D7F, D7G	172.5
9	7T4509G	D7F, D7G	260.0
10	4I7337	E110B, E120B, 311, 312	78.5
11	113-2907	E200B, 315, 320	118.0
12	096-0253	E300B	179.0
13	102-8155	320S, 325	186.8
14	102-8152	330	253.5
15	103-30-00120	D20, D21	64.5
16	113-30-33110	D3D, D31	60.0
17	113-30-00102	D3D, D31	98.0
18	113-30-13115	D50, D55, D60-3	127.0
19	131-30-00285	D50, D55, D60-3	190.0
20	141-30-33111	D60-6, D65, D70	150.5
21	144-30-00038	D60-6, D65, D70	245.0
22	150-30-22118	D80, D85	185.0
23	158-30-00100	D80, D85	330.0
24	175-30-23114	D155	251.0
25	175-30-00575	D155	460.0
26	201-30-00012	PC60-5, PC60-6	65.0
27	203-30-00210	PC100-6, PC120-6, PC130-6	74.2
28	205-30-00182	PC150-3/5, PC180-3/5, PC200-3	125.0
29	20Y-30-00030	PC200-5/6, PC210-5/6, PC220-5/6	154.0
30	207-30-00160	PC300-3/5/6, PC350LC-6	190.0
31	208-30-00200	PC400-5/6, PC450-5/6	272.2
32	9068144	EX100, EX120-1/2	86.0
33	9143388	EX100-3, EX120-3/5, EX130H-5	86.0

序号	零件号	适用机型	重量
No.	Code	Model	Weight (kg)
34	9165598	ZX95, ZX110, ZX120, ZX135	86.0
35	9066393	EX200, EX200-1	106.0
36	9143400	EX100M-5, EX200-2/3, EX220-3	106.0
37	9145269	EX200-5, EX220-5, EX230-5	114.4
38	9151028	EX300-1/2/3	168.8
39	9154690	EX300-5, EX330-5, ZX270, ZX330, ZX350	204.0
40	9099137	EX400-2/3	228.0
41	9134295	EX400-5, EX450-5	228.0
42	24100N4064F1	SK07-N2, K907-II	131.5
43	24100J6379F1	SK09-N2, K909-II	136.0
44	24100N6504F16369F1	SK100, SK120, SK130	86.0
45	24100N5948F2	SK200	113.4
46	24100J1697F1	SK220, SK250	128.0
47	LC52DU0001F1	SK300, SK400	218.0
48	C64200201	MS110-5, MS110-8	92.7
49	C34200801	MS110L-5	134.2
50	094-1384, E34200300	MS180-3, MS180-8, E180, E240	110.5
51	KNA0540	S265, LS2650, SH100	83.0
52	KRA1432	LS2800FJ2, SH200	99.0
53	KSA0783	LS4300FJ2, SH300	177.5
54	2270-1064	DH180, DH200, DH220	113.6
55	2270-1084	DH280, DH320, SOLAR290, SOLAR300	183.0
56	2270-9405	DH450, SOLAR400, SOLAR450, SOLAR470	216.0
57	E181-2004	R200	134.3
58	81EM-14010-20	R200-3, R210, R250	186.0
59	E282-2004	R280	183.0
60	81E8-2004	R290, R320, R360	183.0
61	81E7-01030	R420, R450LC	220.0
62	1081-03790	SE210-2, SE210LC-2	143.5
63	1081-00510	SE280-2, SE280LC-2, SE350-2/5	186.0



支重轮 TRACK ROLLER



TRACK ROLLER 支重轮 FG-0002

序号 NO.	机型 Machine Model	零件号 Genuie Parts No.	重量 (Kg) Weight
1	245	8E-0830	124
2	307/308	127-3806/61-6524	14
3	311/312	151-9747/41-7346	25
4	320/E200B	117-5045/8E-5034	35
5	205	8E-7494/5W4144/7T-6395	34.7
6	215B/225B	7T6394	38.2
7	MS120-8	C84300200	37.4
8	MS180-8/EL240B	957138/A065-00112	41.2
9	322	163-4145/61-9396	36.2
10	325	117-5046/6Y-1057	44.6
11	E300(MITSUBISHI)	854972/A065-00121	
12	E300B(MITSUBISHI)	854973/A065-00122	50.5
13	219	8E-4573	40.5
14	227/229	8E-4576	47
15	235/235B/235C	8E-4579	52.4
16	330	117-5047/6Y-2795	60
17	340(single)	178-7293/123-1379	77.2
18	350	189-0475	93.6
19	E450 (MITSUBISHI)	863096/G643-00200B	84.1
20	PC20-1~7(steel)	20S-30-00060	8
21	PC20(rubber)	20N-35-71300	8
22	PC25/PC30-2(rubber)	20S-30-00021	6.4
23	PC40-6	20T-30-00041	10.2
24	PC40-7	20T-30-00071	8.5
25	PC60-1(steel)	201-30-00050	13.9
26	PC60-6(steel)	201-30-00062	14.5
27	PC60-6(rubber)	21W-30-00021	22
28	PC60-7	201-30-00292	14.7
29	PC75UU-1(rubber)	21W-30-00021	22
30	PC100-3,5/PC120-3,5	203-30-00140	22.8
31	PC100-6/PC120-6	203-30-00220	22.8
32	PC200-3	20Y-30-00130	35.5
33	PC200-5,6	20Y-30-00012	36.5
34	PC300-3	207-30-00130	52.5
35	PC300-5	207-30-00150	51.5
36	PC400-3,5	208-30-00210	78
37	PC650-5	209-30-00191	140
38	PC650LC-6	21M-30-00100	109.1
39	PC1000-1	21N-30-00023	170
40	PC1250-7	21N-30-00121	183.2
41	EX25-1,2/EX30-1,2	4340535/9106668	6.2
42	EX35-1,2	4340535/9106668	6.2
43	EX20UR-1,2/EX30UR-1,2	4340535/9106668	6.2
44	EX40UR-1~3	4340535/9106668	6.2
45	EX40-1/EX45-1	4405892/9106672	9.7
46	EX60-1	9046234/9066207	14.8
47	EX60-2	9096970	13.5
48	EX60-5	9153152/9177016	13
49	EX90-1	9066206	23.1
50	EX100-EX120-1	9066508	23.7
51	EX100-2~5/EX120-2~5	9132600/9092522	22
52	EX100M-1/EX150-1	9114616/9066691	28
53	EX200-1/UH07-5	9114617/9066510	38.2

底盘件系列

序号 NO.	机型 Machine Model	零件号 Genuie Parts No.	重量 (Kg) Weight
54	EX220-1/UH09-7	9114618/9066509	39.5
55	EX200-2,3/EX220-2,3,5	9132602	35
56	EX200-5	9134243	34.6
57	EX300-1	9114619/9066690	57.2
58	EX300-2~5	9168173/9114682	53.5
59	EX400-1~5	4386648/9129347	80.7
60	EX550-5	4348373/9109493	109.1
61	EX750	9151869	144.5
62	EX1100-1~3	9114262/4300532	198
63	EX1800-1~3	9114725/4295201	315
64	EX2500	9134231/4352440	449.5
65	SK045		9.4
66	SK60-1(rubber)	24100N6734F1	14.3
67	SK60-2	24100N6292F2	14
68	K904E	24100N2925F1	26.2
69	SK100-1/SK120-1	24100N4042F2	25
70	K907B	B90N0059F6	36.7
71	K907C/SK07 II	24100J6400F2	36
72	SK09-N2	24100J6186F1	42.7
73	SK200-1	24100N5947F2	35
74	SK220-1	24100J11696F3	45.5
75	SK200-2,3	24100N8009F2	35
76	SK200-5,6	YN64D00013F1	35
77	SK235 SR-1	YN64D00013F1	35
78	SK300-1	24100N3856F3	56.4
79	SK310-2,3	24100N7032F1	68
80	SK330-6	LC64D00005F1	57.5
81	SK200-5,6	YN64D00019F1	35
82	SH100/SH120	KNA0242/KNA0532	25.5
83	SH120-3	KNA0693	21.8
84	SH200(outer)	KRA1189	35
84	SH200(inner)	KRA1190	36
86	SH220(outer)	KBA0869	43.2
87	SH220(inner)	KBA0870	44.2
88	SH220-2(outer)	KBA1047/KBA0432	43.2
89	SH220-2(inner)	KBA1050/KBA0433	44.2
90	LS-2800FJ/FJ2	KRA0781	34.6
91	LS-4300/SH300(Inner)	KSA0672	52.8
92	LS-4300/SH300(Outer)	KSA0671	53
93	LS-5800/SH400(Inner)	KTA0674	68.6
94	LS-5800/SH400(Outer)	KTA0673	69.1
95	HD250VII	767-50800100	11.9
96	HD700	547-50800110	36.8
97	HD820	707-50800101	36.8
98	HD1023	737-50800101	36.8
99	HD1250VII	587-50800100	50.3
100	R200	E181-2002-KW	41.2
101	R290	81E5-2002	51.5
102	R290LC-7	81N8-11010	52.3
103	SE130LC	1081-01580	34.7
104	SE210-2	1081-03680	40.2
105	SE280		53.7
106	DH280.320	2270-9401A	52.4

支重轮 TRACK ROLLER



TRACK ROLLER 支重轮 FG-0002

序号 NO.	机型 Machine Model	零件号 Genuie Parts No.	重量 (Kg) Weight
1	D3B/D3C VE(S)	6S3607/3T4352	21.5
2	D3B/D3C VE(D)	6S3608/3T4353	23
3	D4C/D4D(S)	7K8095/7K8083/1M4218/2Y9611/3B1404 3K2779/4B9716/4E5322/5H6099/5K5203 6B5362/6T9887/7F2465/8B1599 9P4208/9P7783	38.6
4	D4C/D4D(D)	7K8096/7K8084/1M4213/2Y9612/3K2780 4B5291/4B9717/4E5323/5H6101/5K5202 6B6238/6T9883/7F2466/8B1600 9P4211/9P7787	40.5
5	D5/D6B(S)	9S9539/6B9385/1F6471/4K9035 5K4542/4F5311/7F2463/7K8572 3S0741/1M3826/9S9539	46.7
6	D5/D6B(D)	9S9538/6B9386/1F6472/4K9036/5K4543 4F3532/7F2464/7K8571/3S0742 1M3827/9S9538	52.7
7	D5H/953(S)	9P1368	41.5
8	D5H/953(D)	9P1363	46.5
9	D5M(S)	124-8237	32
10	D5M(D)	124-8240	34.2
11	D6C(S)	9S9403/6Y2903/9G8099/1V8052	53
12	D6C(D)	9S9404/6Y2903/9G8098/1V8051	60
13	D6C(S) (Without Key)	118-1614	53
14	D6C(D) (Without Key)	118-1615	60
15	D6D(S)	7G0421/9G8029	53
16	D6D(D)	7G0423/9G8034	60
17	D6D(S) (Without Key)	118-1617	53
18	D6D(D) (Without Key)	118-1618	60
19	D6R(S)	120-5746	54
20	D6R(D)	120-5766	60.5
21	D6M(S)	121-0824	45.1
22	D6M(D)	121-0827	49.8
23	D6H(S)	774102	51.3
24	D6H(D)	774107	58
25	D7F/D7G(S)	9S0316/6T9871/3P1520/3P6062 4S9050/4S9051	69
26	D7F/D7G(D)	9S0317/6T9867/3P1521/3P6063 6P9885/8S2932/8S2933	77
27	D7F/D7G(S) (Without Key)	118-1623	69
28	D7F/D7G(D) (Without Key)	118-1625	77
29	D7C/D7D/D7E(S)	1P9100/6B3137/7B9458/8B5159/1F6212 2F3085/7F2469/8H0780/8H0876/7M5115 8M5113/1P9403/8P0963/3S 0743/3S0745/4S8280/9S728	69
30	D7C/D7D/D7E(D)	1P9102/6B6123/7B9459/8B9160/1F6213 2F3086/7F2470/8H0781/8H0877/7M5116 8M5114/1P9402/8P0946/3S0744/3S0746 4S8981/9S7286/9S3395	77
31	D7C/D7D/D7E(S) (Without Key)	118-1619	69
32	D7C/D7D/D7E(D) (Without Key)	118-1620	77
33	D7R(S)	124-8250	72.5
34	D7R(D)	124-8253	80.5
35	973C(S)	134-6636	72.5
36	973C(D)	134-6637	80.5
37	D7H(S) VE	9W5586/6T0067	64
38	D7H(D) VE	9W5585/6T0068	70.3
39	D8N(S)	9W8705/7G9188	91.2
40	D8N(D)	9W8706/7G9193	100
41	D8K(S)	6P4897/7S9041/9H6449/9P3308	109.7
42	D8K(D)	6P4898/7S9042/9H6451/9P3309	122.7
43	D8L(S)	9W7826/7G7594/2Y8240/2Y8489/7T2018	88.3
44	D8L(D)	9W7827/7G7595/2Y8239/2Y8709	95.6
45	D9G/D9H(S)	8P5605/7S7672/4M0582/7S7672	152.9
46	D9G/D9H(D)	8P5604/7S7673/4M0583/7S7673	164.9
47	D9N/D9R(S)	7T1258	108.5
48	D9N/D9R(D)	7T1253	112.5
49	D9L(S)	6Y2950/9G8641/7T1831	127.6
50	D9L(D)	6Y2951/9G8642	132.3
51	D10N/D10R(S)	6Y0889	147
52	D10N/D10R(D)	6Y0890	155.8
53	D20 VE(S)	101-30-00042/201-30-00050	14.5
54	D30-12 VE(S)	113-30-00130/111-30-00274/111-30-00272	28.3

序号 NO.	机型 Machine Model	零件号 Genuie Parts No.	重量 (Kg) Weight
55	D40-1(S)	140-30-00053/131-30-00320/140-30-00072	45.3
57	D40-1(D)	131-30-00321/140-30-00052	
58	D50-15/D60-3(S)	140-30-00063/131-30-00330/140-30-00082	53.8
59	D50-15/D60-3(D)	131-30-00331/140-30-00062	
60	D41-6(S)	131-30-00322	45.3
61	D41-6(D)	131-30-00332	53.8
62	D61(S)	124-30-52502	34
63	D61(D)	124-30-52602	39.2
64	D60-6(S)	131-30-00342	49.1
65	D60-6(D)	131-30-00352	54.9
66	D65-12(S)	141-30-00578/141-30-00570/207-30-00022	55
67	D65-12(D)	141-30-00571/141-30-00576	
68	D80-12(S)	141-30-00588/141-30-00580	61.5
69	D80-12(D)	141-30-00581/141-30-00586	
70	D80-18(S)	207-30-00040 14X-30-00081 14X-30-00091	54.9
71	D80-18(D)	154-30-00505/150-30-00066 154-30-00500/154-30-00501 154-30-00502/154-30-00504 154-30-00405/150-30-00056/154-30-00402 154-30-00400/154-30-00401	81.3
72	D80-18(S)	155-30-00126/155-30-00250/155-30-00128 145-30-00250/145-30-00320 154-30-00503/155-30-00120 155-30-00121/155-30-00122 155-30-00123/155-30-00124	71.5
73	D80-18(D) (Without Key)	155-30-00116/155-30-00240/155-30-00118 145-30-00260/145-30-00330 154-30-00403/155-30-00110 155-30-00111/155-30-00112 155-30-00113/155-30-00114	82
74	D150A-1/D155A-1(S)	155-30-00115/155-30-00114 175-30-00486/175-30-00760 175-30-00480/175-30-00481 175-30-00489/175-30-00544	106
75	D150A-1/D155A-1(D)	175-30-00496/175-30-00770 175-30-00490/175-30-00491 175-30-00499/175-30-00554 175-30-00486/175-30-00760	117.5
76	D150A-1/D155A-1(S)	175-30-00499/175-30-00554 175-30-00486/175-30-00760 175-30-00480/175-30-00481 175-30-00489/175-30-00544	106.3
77	D150A-1/D155A-1(D)	175-30-00496/175-30-00770 175-30-00490/175-30-00491 175-30-00499/175-30-00554	117.8
78	D155AX-3(S)	17A-30-00070	98.6
79	D155AX-3(D)	17A-30-00080	109.1
80	D275-2(S)	17M-30-00220	111.6
81	D275-2(D)	17M-30-00230	123.6
82	D275A-5(S)	17M-30-00320	118.6
83	D275A-5(D)	17M-30-00330	128.3
84	D355A-3(S)	195-30-00336/195-30-00114 195-30-00115/195-30-00116 195-30-00117/195-30-00118 195-30-00331/195-30-00332 195-30-00346/195-30-00124 195-30-00125/195-30-00126 195-30-00127/195-30-00128 195-30-00341/195-30-00342	159
85	D355A-3(D)		168.5
86	D375A-1(S)	195-30-00562	128
87	D375A-1(D)	195-30-00572	139
88	D375A-2(S)	195-30-01010	138
89	D375A-2(D)	195-30-01020	153

底盘件系列



驱动轮 SPROCKET



SPROCKET 驱动轮 FG-0002

序号 No.	零件号 Code	适用机型 Model	规格 Standards	重量 (kg) Weight
1	6Y2047	D3B, D3C	25T25H/5	19.5
2	7K2514, 4V4107	D4D	29T	39
3	5S0836	D5	27T27H/9	46.8
4	6P9102	D6C, D6D	25T20H/5	55.5
5	117-1616	D6D-LS	25T20H/5	55.5
6	7G7212	D6H	25T25H/5	57.5
7	9P1898	D7H	25T25H/5	74
8	3P1039, 5S0052	D7F, D7G	25T20H/5	73.5
9	2P9510	D8H, D8K	27T27H/9	105.3
10	4I7472	E110B, 311B, 312B, 314C	21T15H	39.3
11	095-7412	E180, MS180-8	23T22H	53
12	096-4327	E200B	21T14H	47.8
13	8E9805	318B, 320B, 320C	21T16H	38.5
14	6Y4898	320S, 325, 325B, 325N	21T18H	53.5
15	6Y5685	330, 330B	23T16H	94.5
16	113-27-31320	D30, D31, SD08	25T16H	40
17	131-27-61710	D40, D50, D53	27T27H/9	64.8
18	141-27-32410	D60, D65, D70, SD16, TY160, PD165	27T27H/9	70.2
19	155-17-00151	D80, D85, SD22, TY220	25T25H/9	70.8
20	175-27-22235	D155, SD32, TY320, PD320	27T27H/9	108
21	201-27-41110	PC60-5	23T12H	23
22	21W-27-11110	PC60-6	21T12H	22.3
23	203-27-41111	PC100-3, PC120-3	25T15H	44
24	203-27-51310	PC100-5, PC120-5	21T15H	33.8
25	205-27-71281	PC200-3	21T20H	39
26	20Y-27-11581	PC200-5/6/7, PC220-5/6/7	21T20H	39
27	207-27-33222	PC280, PC300-3/5	22T20H	52.9
28	207-27-61210	PC300-6/7, PC350-6	21T20H	67
29	208-27-31221	PC400-3/5	23T26H	66
30	208-27-61210	PC400-6/7, PC450-6	21T20H	69
31	1005954	UH07-3, UH083	23T16H	60.4
32	1010325	EX100, EX120, ZX95, ZX110, ZX120	21T16H	33
33	1010204	EX100M-5, EX200-1, ZX110M, ZX200	23T16H	52

序号 No.	零件号 Code	适用机型 Model	规格 Standards	重量 (kg) Weight
34	1010203	EX200-2, EX220	21T16H	44
35	1018740	EX200-3, EX200-5	21T16H	46.4
36	1010467	EX270-1/2, EX300-1/2/3	21T16H	59
37	1022168	EX300-5, EX330-5, ZX270, ZX350	21T20H	89
38	1010956	EX400-2/3/5, EX450-5, ZX450	23T24H	77
39	2404N246	SK07-2, SK07-II	23T16H	56
40	2404N251	SK07-N2, 907-II	25T20H	56
41	2404N416	SK100, SK120	21T15H	36.5
42	2404N414	SK200MARK III/IV	21T22H	47
43	2404N262	SK200SR, SK210LC-GE, SK250MARK III	21T20H	65
44	LCS3DU000P1*	SK300 MARK III/IV, SK330 MARK III/IV	23T26H	98.8
45	KRA0777	LS280, LS280FJ1	21T21H	46
46	KRA0436, KRA0856	S280, LS800FJ2, HD770	23T22H	51.3
47	KRA1109, KRA1665	SH200, HDR20	21T22H	52
48	KSA0643	LS430FJ2, SH300	23T24H	109.2
49	2108-1014	DH180, DH200, DH220	23T22H	45.2
50	2108-1028	SOLAR200, SOLAR 220, SOLAR 225	23T16H	45.2
51	2108-1015	DH280, DH280LC-2, SOLAR280LC-3	23T16H	55
52	2108-1024	DH320	23T24H	60.8
53	2108-1031B	SOLAR450-III, SOLAR450LC-V	23T24H	65
54	E181-2001	R200, R200LC	23T16H	33
55	81EM-10010	R200-III, R210-III, R250LC-III	21T16H	44
56	E282-2001	R280, R280LC	23T16H	60
57	81E5-2001	R290, R320LC	23T16H	76.2
58	1081-60001	SE210, SE210LC	23T22H	36
59	1081-03710	SE210-2, SE210LC-2	21T22H	52.2
60	1081-03900	SE280-2, SE280LC-2	23T24H	82
61	1081-01850	SE350LC-2, SE350LC-5	21T24H	78.6

履带螺栓/螺母 TRACK BOLT & NUT 齿块螺栓/螺母 SEGMENT BOLT & NUT 刀角螺栓/螺母 PLOW BOLT & NUT



TRACK BOLT & NUT 履带螺栓/螺母 FG-0002

序号 No.	零件号 Code	尺寸 Dimension
1	2b5484/7k1706	7/16"*1 19/16"UNF
2	102-8072/1028073	1/2"*1 3/8"UNF
3	093-0251/093-0316	1/2"*1 1/2"UNF
4	8H7504/6S3419	1/2"*1 1/2"UNF
5	4K7038/7K2017	9/16"*1 5/8"UNF
6	7H3596/7K2017	9/16"*1 15/16"UNF
7	5A3187/7K2017	9/16"*3"UNF
8	7H3597/1M1408	5/8"*2 3/32"UNF
9	9G3110/1M1408	5/8"*2 5/32"UNF
10	5A4104/1M1408	5/8"*2 3/8"UNF
11	1S1859/1S1860	3/4"*2 5/32"UNF
12	7H3598/1S1860	3/4"*2 13/32"UNF
13	6V1792/1S1860	3/4"*2 7/16"UNF
14	5A7524/1S1860	3/4"*4"UNF
15	7H3599/2S2140	7/8"*2 21/32"UNF
16	7T2748/7G6442	7/8"*3 11/32"UNF
17	6V1732/7G6442	7/8"*3 13/32"UNF
18	2M5657/1S6421	1"*2 15/16"UNF
19	3T6308/2V0250	1"*3 1/8"UNF
20	6T2638/7G0343	1"*3 35/64"UNF
21	6V1726/7G0343	1"*3 3/16"UNF
22	7T1000/5P8221	1 1/8"*3 25/32"UNF
23	5P3868/5P8221	1 1/8"*4 13/32"UNF
24	093-0251/093-0316	M13*1.5*38
25	M1345	M13*1.25*45
26	203-32-21210/01803-01420	M14*1.5*48
27	M1456	M14*1.5*56
28	4I7538/5I6125	M16*1.5*46
29	M1456	M16*1.5*48
30	LP60D01001P1	M16*1.5*51
31	203-32-51210/203-32-51220	M16*1.5*53

序号 No.	零件号 Code	尺寸 Dimension
32	096-1043/093-0319	M16*1.5*55
33	M1657	M16*1.5*57
34	M1660	M16*1.5*60
35	093-0259/093-0391	M16*1.5*68
36	M1855	M18*1.5*55
37	135-32-11211/135-32-11221	M18*1.5*57
38	093-0262/093-0320	M18*1.5*58
39	M1960	M19*1.5*60
40	M1965	M19*1.5*65
41	M1969	M19*1.5*69
42	20Y-32-11210/154-32-31220	M20*1.5*55F
43	9W3619/9W3361	M20*1.5*55
44	14X-32-05000/14X-32-11220	M20*1.5*56
45	M2057	M20*1.5*57
46	2404T2749	M20*1.5*60
47	207-32-11350/01803-02026	M20*1.5*63
48	6Y0846/9W3361	M20*1.5*63
49	M2065	M20*1.5*65
50	154-32-11230/154-32-31220	M20*1.5*68
51	093-0265/093-0321	M20*1.5*70
52	207-32-51210/207-32-51220	M22*1.5*56F
53	4229948/4198449	M22*1.5*66
54	6Y9024/9W4381	M22*1.5*67
55	8E6103/9W4381	M22*1.5*73
56	093-0268096-0586	M22*1.5*78
57	208-32-51210/208-32-51220	M24*1.5*65F
58	176-32-11210/178-32-11220	M24*1.5*75
59	093-0271/096-0323	M24*1.5*81
60	195-32-11210/195-32-11221	M27*2.0*82
61	6Y7432/6Y7433	M27*2.0*90
62	195-32-61210/195-32-31221	M30*2.0*96

SEGMENT BOLT & NUT 齿块螺栓/螺母

序号 No.	零件号 Code
1	9W9265/8H5724
2	3S8182/7H3607
3	6V0937/7H3607
4	3S0336/7H3608
5	SP7665/7H3608
6	9S2727/7H3609
7	5P4130/7H3608
8	5P0233/ZM5656
9	9W8328/7H3609

MT-8014

序号 No.	零件号 Code
10	7T1248/7H3609
11	5P5422/ZM5656
12	09203-11860/01803-11824
13	154-27-12320/01803-32228
14	154-27-12181/01803-02228
15	178-27-11150/01803-02430
16	195-27-12632/-1803-2430
17	195-27-31641/195-27-31871

PLOW BOLT & NUT 刀角螺栓/螺母 MT-8015

序号 No.	零件号 Code	尺寸 Dimension
1	4F3654/4K0376	5/8"*2"UNC
2	3F5108/4K0376	5/8"*2 1/4"UNC
3	4F3656/4K0376	5/8"*2 1/2"UNC
4	4F3657/4K0376	5/8"*2 3/4"UNC
5	4F3658/4K0376	5/8"*3"UNC
6	4F7827/2J3506	3/4"*2 1/4"UNC
7	5J4773/2J3506	3/4"*2 1/2"UNC
8	5J4771/2J3506	3/4"*2 3/4"UNC
9	1J6767/2J3506	3/4"*3"UNC
10	4F0253/2J3506	3/4"*4 1/2"UNC
11	6F0196/2J3505	7/8"*2 3/4"UNC
12	5J2409/2J3505	7/8"*3"UNC

序号 No.	零件号 Code	尺寸 Dimension
13	2J2548/2J3505	7/8"*3 1/2"UNC
14	1J5607/2J3507	1"*2 3/4"UNC
15	4F4202/2J3507	1"*3"UNC
16	4J9058/2J3507	1"*3 1/4"UNC
17	4J9208/2J3507	1"*3 1/2"UNC
18	8J2928/2J3507	1"*3 3/4"UNC
19	5P8136/2J3507	1"*4"UNC
20	8T8079/3K9770	11/4"*3 1/2"UNC
21	6V6535/3K9770	11/4"*3 3/4"UNC
22	5P8823/3K9770	11/4"*4"UNC
23	6V8360/3K9770	11/4"*4 1/2"UNC
24	5P8361/3K9770	11/4"*5"UNC